

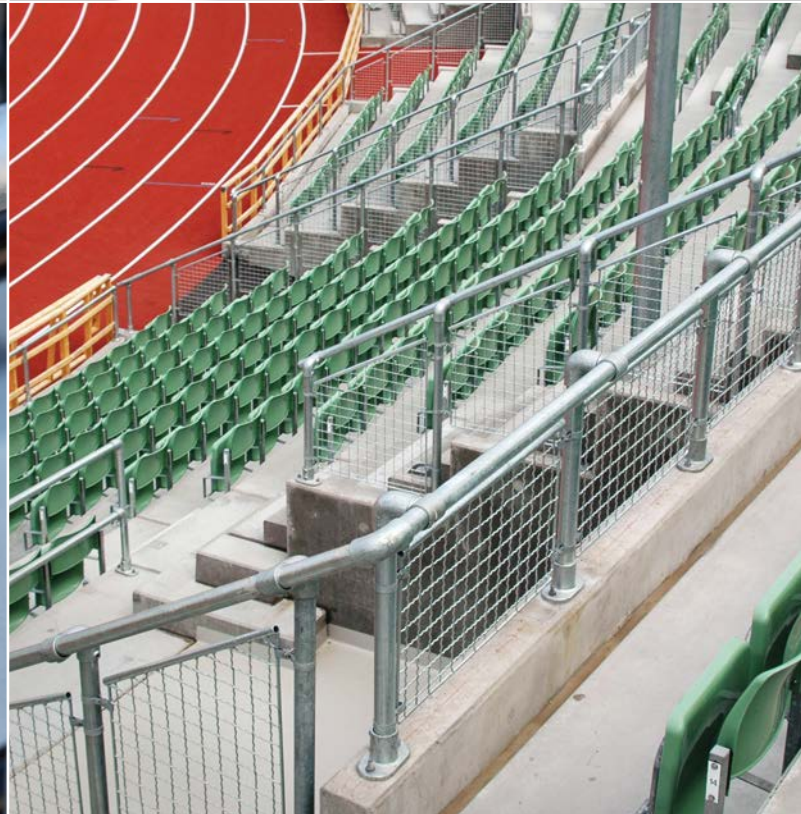

YOU'LL NEVER BE BETTER PROTECTED

Components for Safety Barrier Solutions



THE KEE KLAMP® CONCEPT

Kee Safety® is a leading global supplier of components and bespoke safety systems. Our systems are quick and easy to design and install, and are very cost effective due to their modularity.



Galvanised cast iron modular component

Case hardened set screw

Galvanised steel tubing

CONTENTS

1. Technical information	Page 4
2. Kee Klamp components	Page 6
3. Kee Klamp range of access components	Page 32
4. Kee Lite components	Page 40
5. Accessories	Page 54
6. Specifying components	Page 56
7. Meeting safety standards	Page 57
8. Assembly and installation	Page 58
9. Load tables	Page 66
10. Vibration tests	Page 69

The principle is simple yet highly effective, proven over 80 years in thousands of completed projects across the globe. Whether you need to separate people from hazards or protect your equipment on site, Kee Safety offers the most cost effective, flexible and safe solutions to your barrier requirements.

Safety

Kee Safety regularly monitors all new safety standards and directives to ensure the highest protection. Our systems not only meet but also exceed the current safety requirements and our components comply with the latest UK Building Regulations and European Standards.

Quality

Quality is the overriding priority when manufacturing Kee Safety components. Components are manufactured to strict specifications and TÜV certified for strength, manufacturing quality and consistency.

Solutions

From simple protection for loading bays or safety walkways in factories, to safety barriers in aggressive coastal environments or the protection of road bridges and culverts, Kee Safety provides you with confidence that you are compliant with safety requirements.

Kee Klamp®



An innovative product for the construction of steel tubular structures. Kee Klamp® components are galvanized cast iron for strength and corrosion resistance.

Go to page **6**

The Kee Klamp access range of galvanized cast iron components are suitable for stairs, ramps and walkways. They are specially designed for disabled access, meeting the requirements of Building Regulations part 'M' and the Equality Act.

Go to page **32**

Components manufactured from a polished high grade aluminium alloy for the construction of lightweight tubular structures. Kee Lite® components offer superior corrosion resistance, strength and durability.

Go to page **40**

TECHNICAL INFORMATION

Tubes for your Structure

Kee Safety components are produced in a range of standard sizes to suit medium and heavy gauge steel tubing manufactured to BS EN 10255 (ISO 65).

Tubing of other specifications can be used, providing the steel is compatible with BS EN 10255 (ISO 65) and wall thickness is not less than 3.2mm.

KEE KLAMP Tube size	Tube diameter (mm o.d.)	Nominal Bore* (mm)
3	17.5	10
4	21.3	15
5	26.9	20
6	33.7	25
7	42.4	32
8	48.3	40
9	60.3	50

* Nominal bore is an arbitrary dimension, because the bore varies with the wall thickness of the tubes.

TÜV Approved

Kee Safety components are approved by TÜV, Europe's leading independent testing house. The maximum load of each component type is as stated on the TÜV Certificate, a copy of which is available upon request. For an up-to-date TÜV listing see our website at www.keesafety.co.uk.

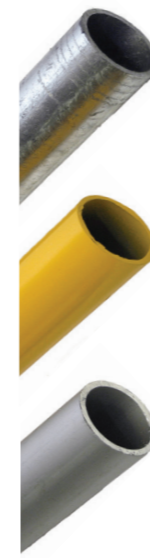
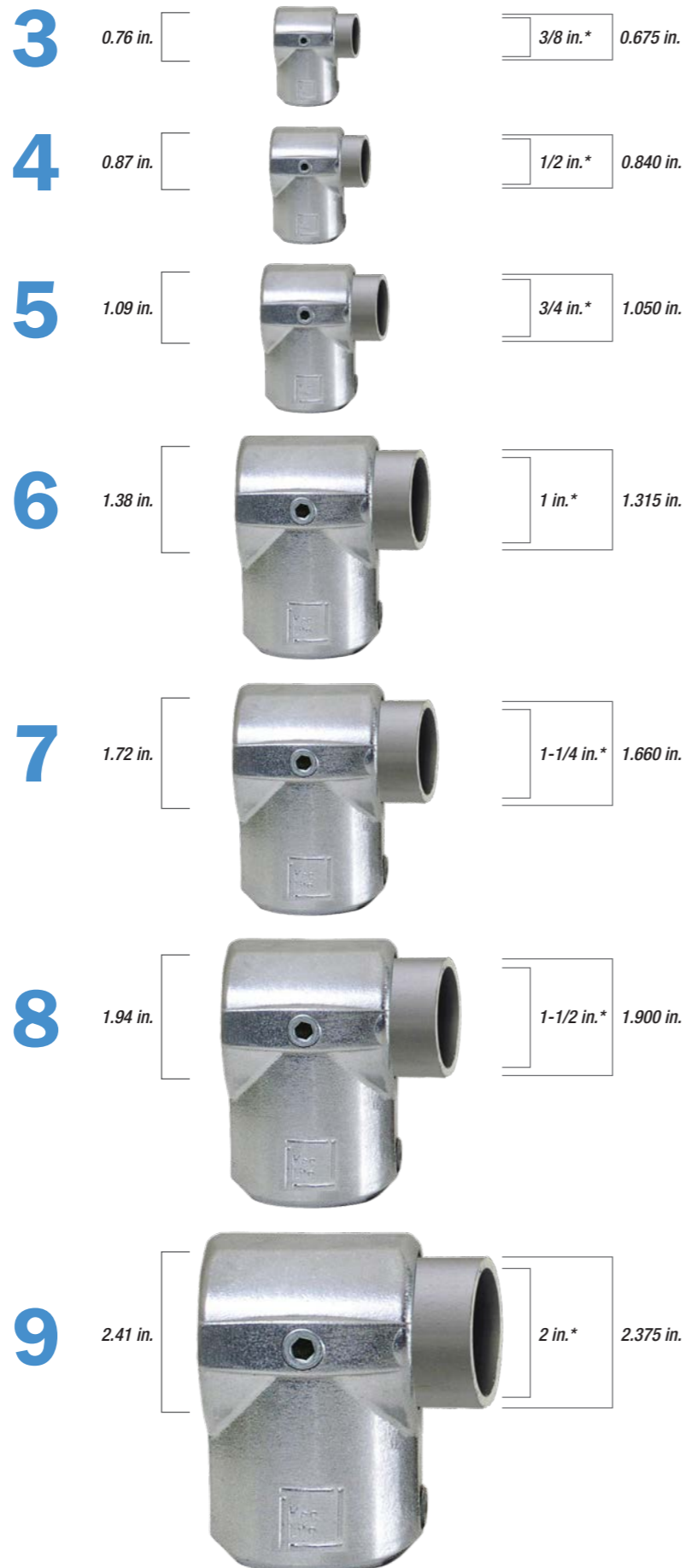

Galvanised Steel

Kee Klamp and Kee Klamp access components are supplied hot dip galvanised to BS EN ISO 1461.

Powder Coating

Durable, polyester coating applied to already galvanised/polished products; available in any RAL colour.

Aluminium

Kee Lite components are made from high grade Aluminium Silicon Magnesium Alloy.



RAL Colours

The broad colour range offers a variety of visual contrast options. These colours will enhance any handrail, guardrail, balustrade or a multitude of applications.

Anti-Bacterial Coating

Defence against the growth of potentially harmful invisible bacteria and fungi; this powder coating can be applied in a wide range of RAL colours.

Selecting Kee Safety Components

Every component is illustrated and accompanied by a table of sizes and weights. Each component has a simple numerical code reference, which is unique and differentiates it from every other component. The code defines the type of component and the tube size or sizes it is designed to receive.

25

Three Socket Tee

Most commonly used as the 90° joint between the top-rail and an intermediate upright on safety railing. As there are two socket set screws in the sleeve, this component can be used where a join is required in the horizontal tube. The Type 10 component can be used as an alternative when a join in the tube is not required.

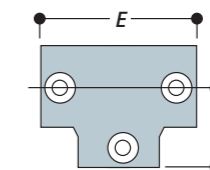
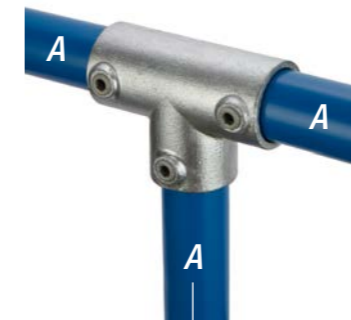

TYPE	Tube ref.	in.		lb.
	A	D	E	
25-4	4	1.34	2.68	0.40
25-5	5	1.61	3.23	0.82
25-6	6	1.81	3.62	1.08
25-7	7	2.36	4.72	1.87
25-8	8	2.68	5.35	2.40
25-9	9	3.35	6.61	3.84

Component type, name and description

Letter corresponds with tube reference in the table

Each letter in the drawing has a corresponding measurement in the table

First number preceding the dash identifies the component type

The single digit following the dash defines the tube size. (Two digits after the dash indicate that the component is designed to receive two sizes of tube, and likewise with three digits.) See opposite page for tube reference digits related to actual tube dimensions

Note: Kee Safety can provide general guidance on the use of the components detailed in this catalogue. However, the nature of the product means that the ultimate responsibility for selecting the correct component for an application rests with the customer. The customer should also ensure that any existing structure to which a Kee Safety component is being secured is of sufficient strength to support both the weight of the Kee Safety construction and the imposed loads applied, including wind loads, snow loads and any other superimposed loads.

Kee Klamp®

Galvanised Iron Components

The engineering principle behind the Kee Klamp component is the foundation of the most versatile tube connection system available. We provide the versatility needed to achieve virtually any structure configuration.



A SUPERIOR SOLUTION

Steel tube is an inherently efficient structural component. It is strong, has no sharp corners, and is readily available worldwide. The difficulty in using steel tube to form structures arises when joining. Threaded tube must be supplied in set lengths making for zero flexibility in installation. Welding is labour intensive, requires a highly skilled workforce, and specialised equipment.

Kee Klamp components are iron castings manufactured to the requirements of BS EN 1562 and 1563.

Kee Klamp component have the the widest seletion composing a range of components to suit seven different sizes of tube.

Hexagon socket set screws firmly lock the component to the tube. Set screws are manufactured in case hardened steel and are protected against corrosion with Kee Koat. This ensures that tubular structures achieve longer life and better corrosion resistance.

A Kee Klamp component (size 5 to 9) can support an axial load of 2000 lbs. per set screw with the set screw tightened to a torque of 29lbs./ft; rating includes a safety factor of 2:1. This is normally obtained when the set screw is fully tightened using a ratchet wrench.

Components by Function

BASES

- 62** Standard Railing
- 63** Angle Base
- 363** Angle Base Flange 11°–30°
- 64** Vertical Railing
- 65** Horizontal Railing
- 66** Ground
- 67** Angle
- 68** Wall
- 69** Rail w/ Toe Adaptor
- 115** Wall
- 262** Round Flange
- 265** Offset Rail Wall
- 316** Parapet Clips

CLIPS

- 79** Sheeting
- 81** Single Sided
- 82** Double Sided
- 105** Sheeting w/o hardware

COUPLINGS

- 14** Straight
- 18** Internal
- 145** Crossover Crosses

CROSSES

- 26** Two Socket
- A26** Split Two Socket
- 326** Level to Sloping Down or Up 30°–45°
- 328** Two Socket Cross 11°–30°
- 30** Adjustable 30°–45°
- 35** Three Socket
- A35** Split Three Socket
- 40** Four Socket
- A40** Split Four Socket
- 89** Two Socket Angle
- 91** PGR Two Socket Cross
- 623** High Capacity Base Flange

CROSSOVERS

- 17** Clamp-on
- 45** Crossover
- A45** Split
- 46** Combination Socket Tee
- 121** Corner

ELBOWS

- 15** 90°
- 20** Side Outlet
- BC53** Swivel
- 55** Obtuse Angle
- 55A** Variable 11°–30°
- 56** Acute Angle
- 56A** Acute Angle 11°–30°
- 87** Angle
- 92** PGR
- 320LH** Left hand level to Sloping Down Side 30°–45°
- 320RH** Right hand level to Sloping Down Side 30°–45°

FLANGES

- 31** Pallet
- C58** Swivel
- P58** Double Central Flange
- 59** Spigot
- 60** Extra Heavy
- 61** Flange
- 70** Rail Support

SWIVEL SOCKETS

- C50** Single Combination
- F50** Female Single
- M50** Male Single
- MH50** Male Single Horizontal
- C51** Double
- M51** Male Double Member
- MH51** Male Double Horizontal Member
- C52** Corner
- M52** Male Corner
- C53** Adjustable Three Way
- M53** Variable Angle Double
- M58** Swivel Flange Plate
- 78/83** Gate Hinge Set Tab Panels

TAB PANELS

- P50** Offset Sing. w/ Slot
- P51** Offset Double w/ Slot
- P57** Single w/ Slot
- P57E** Modified P57
- P58** Double w/ CSH

TEES/SOCKETS

- 10** Single Socket
- A10** Split Single Socket
- 12** Single Socket 45°
- A12** Split Single Socket 45°
- 16** Clamp-on
- 19** Adjustable Side Outlet
- 21** 90° Side Outlet
- A21** Split 90° Side Outlet
- 25** Three Socket
- 327** Three Socket 11°–30°
- 427** Three Socket Tee 30°–45°
- 29** Single Socket 30°–60°
- 329** Single Socket Tee 11°–30°
- 46** Combination Crossover
- 8** Angle
- 88** Three Socket Angle
- 90** PGR Three Socket
- 93** Pedestrian Guard Rail
- 114** Swivel
- 321LH** Left hand level to Sloping Down Side Outlet 30°–45°
- 321RH** Right hand level to Sloping Down Side Outlet 30°–45°
- 325** Level to Sloping Down 30°–45°
- 325A** Level to Sloping Up 30°–45°

PLUGS

- 77** Plastic
- 84** Malleable

MISCELLANEOUS

- 32** Decorative Ball
- 71** Weather Cap
- 72** Stair Tread Support
- 75** Collar
- 76** Hook
- 95** PGR Internal Spigot
- 97** Set Screw
- 99** Hex Key
- 100** Plastic Set Screw Caps
- S115** Packer Plate for Type 115
- 118** Rose Cover
- 350** Eaves Fitting
- 351** Ridge Fitting

10

Single Socket Tee

This component creates a 90° perpendicular joint between two tubes.

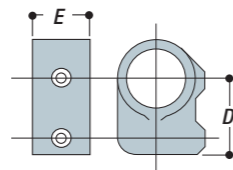
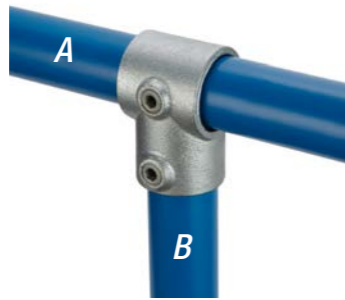

TYPE	Tube ref.		in.		lb.
	A	B	D	E	
10-3	3	3	1.13	0.94	0.15
10-4	4	4	1.36	1.20	0.29
10-5	5	5	1.63	1.47	0.51
10-6	6	6	1.81	1.84	0.64
10-65	6	5	1.75	1.42	0.55
10-67	6	7	2.20	2.06	0.95
10-7	7	7	2.38	2.16	0.99
10-75	7	5	2.25	1.44	0.71
10-76	7	6	2.25	1.80	0.95
10-78	7	8	2.88	2.38	1.39
10-8	8	8	2.69	2.38	1.28
10-87	8	7	2.47	2.03	1.10
10-9	9	9	3.31	2.88	2.14
10-98	9	8	2.94	2.50	1.43

A10

Split Single Socket Tee

Designed to allow additions or extensions to existing structures, this component creates a 90° perpendicular joint between two tubes without the need for dismantling. This component has strength and function comparable the standard Type 10.

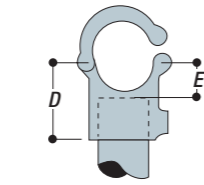
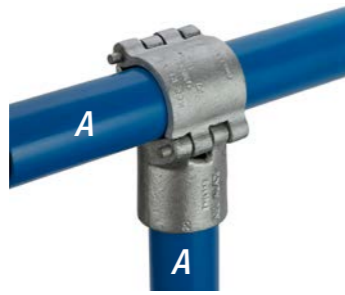

TYPE	Tube ref.		in.		lb.
	A	D	E		
A10-7	7	2.36	1.10	1.26	
A10-8	8	3.46	2.36	1.59	

Note: The A10-8 differs from the picture because it is formed with the A21/A26 components.

12

Single Socket Tee (45°)

Engineered to create 45° angle, this component is most frequently used for bracing and struts.

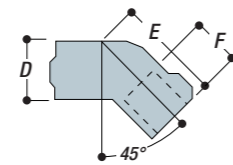

TYPE	Tube ref.		in.			lb.
	A	D	E	F		
12-5	5	1.46	2.83	1.38	0.66	
12-6	6	1.73	3.35	1.38	0.95	
12-7	7	2.17	3.70	1.58	1.56	
12-8	8	2.36	4.25	1.58	2.02	

A12

Split Single Socket Tee (45°)

The hinge and pin system of this component enables existing structures to be easily extended without the need for dismantling. This component is most frequently used for bracing and struts.

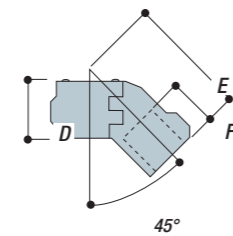
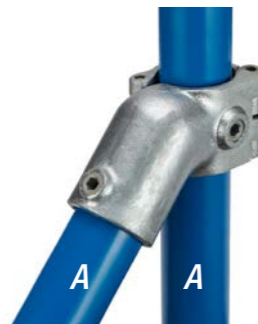

TYPE	Tube ref.		in.			lb.
	A	D	E	F		
A12-8	8	2.36	4.80	2.05	2.36	

14

Straight Coupling

Designed to form an in-line joint between two pieces of tube of the same size. The Type 14 Straight Coupling creates a joint on the outside of the tube and is stronger than internal couplings.

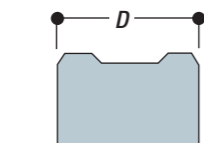

TYPE	Tube ref.		in.		lb.
	A	D	D	E	
14-4	4		2.28		0.31
14-5	5		3.03		0.60
14-6	6		3.50		0.86
14-7	7		4.01		1.15
14-8	8		4.09		1.41
14-9	9		4.88		2.38

15

Elbow (90°)

This elbow creates a 90° joint between two pieces of tube.

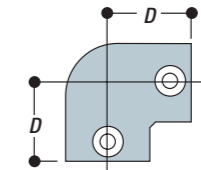
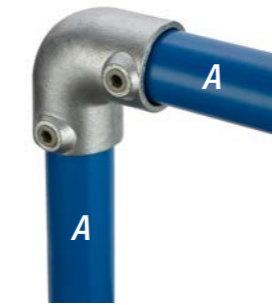

16

Clamp-on Tee

Widely used for adding to and modifying existing structures, this component performs the same function as a Type 10. Because of its open socket, it can be added to a complete structure. The hex head bolt is for retaining purposes only and should be tightened to 15Nm.

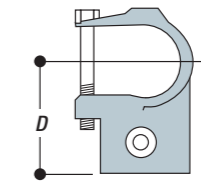
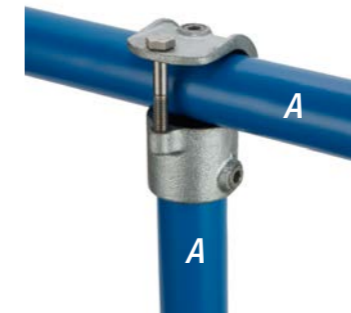

17

Clamp-on Crossover

Designed to provide a 90° crossover joint. Can be added to an existing structure. Tube should not be joined within this component. For an alternative component, see Type 45 or Type A45.

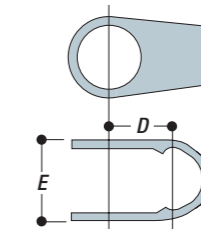
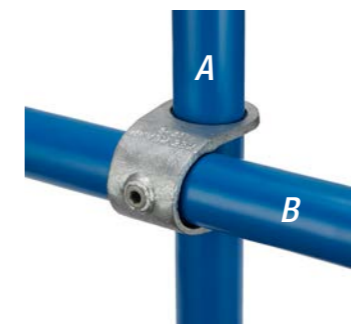

18

Internal Coupling

The Internal Coupling creates a flush joint between two tubes of the same diameter. This component should not be used where a direct tensile load is applied.

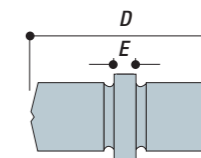

Note: This component can only be used with tube wall with a thickness of 3.2 mm.

TYPE	Tube ref.		in.		lb.
	A	D	D	E	
15-4	4		1.33		0.29
15-5	5		1.61		0.60
15-6	6		1.81		0.86
15-7	7		2.36		1.48
15-8	8		2.67		1.70
15-9	9		3.34		2.82

TYPE	Tube ref.		in.		lb.
	A	D	D	E	
16-5	5		1.97		0.64
16-6	6		2.09		0.73
16-7	7		2.64		1.30
16-8	8		3.03		1.32
16-9	9		3.54		2.03

TYPE	Tube ref.		in.			lb.
	A	B	D	E		
17-5	5		1.06	1.61	0.33	
17-6	6		1.34	1.89	0.51	
17-7	7		1.69	2.48	0.95	
17-8	8		1.93	2.68	1.23	
17-9	9		2.40	3.07	1.98	

TYPE	Tube ref.		in.		lb.
	A	D	E		
18-6	6		2.99	0.79	0.57
18-7	7		2.99	0.79	0.84
18-8	8		3.74	0.79	1.19

WARNING: Type 18 coupling must not be used as a load bearing joint.

19

Adjustable Side Outlet Tee

Used in pairs to form variable angle joints between 90° and 180°. Type 19-8T can produce an angle range between 60° and 180°.

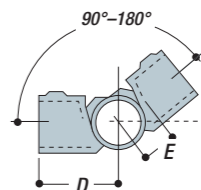
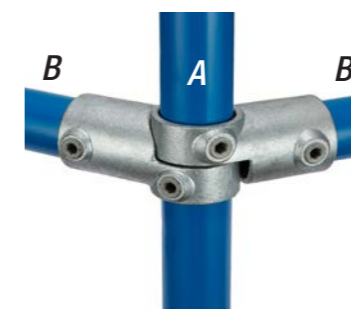

Note: Pairs sold and priced separately in UK, France, and Germany.

TYPE	Tube ref.		in.		lb.
	A	B	D	E	
19-5	5	5	2.36	1.22	0.44
19-6	6	6	2.28	1.30	0.64
19-7	7	7	2.87	1.57	0.90
19-8	8	8	3.54	2.17	1.17
19-85	8	8	2.87	1.77	1.43
19-8T	8	8	-	-	-
19-9	9	9	4.33	1.93	2.18

20

Side Outlet Elbow

This component creates a 90° corner joint for three pieces of tube. Most frequently used for the top-rail of safety railing, it can also be considered for the corner joint of benches, work tables, and other rectangular structures.

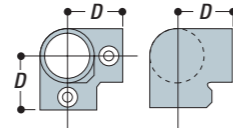
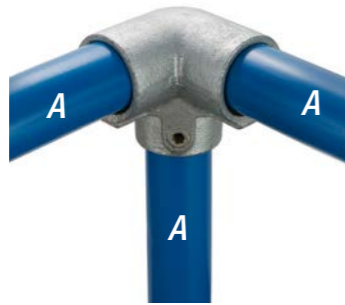

TYPE	Tube ref.	mm	Kg
20-4	A	D	0.26
20-5	5	41	0.38
20-6	6	46	0.48
20-7	7	60	0.70
20-8	8	68	0.99
20-9	9	84	1.82

21

Side Outlet Tee (90°)

Most frequently paired with Type 20 to give a 90° corner joint for the middle rail of safety railing and other rectangular structures. The upright passes through the component.

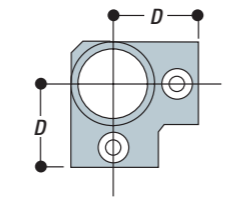
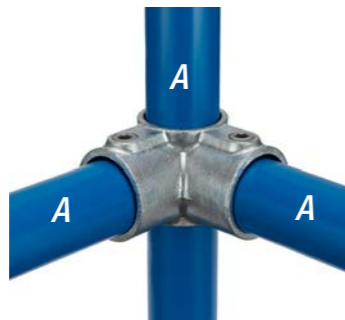

TYPE	Tube ref.	mm	Kg
21-4	A	D	0.14
21-5	5	41	0.28
21-6	6	46	0.41
21-7	7	60	0.55
21-8	8	68	0.73
21-9	9	85	1.36

A21/A26

Split Two socket Cross/ Side Outlet Tee (90°)

This component performs the same function as either Type 21 or Type 26. Because of its hinge and pin system, it can be added to an existing tubular assembly. Type A21/A26 components are supplied and priced as a kit that includes two castings and two taper pins, which can be assembled in either configuration.

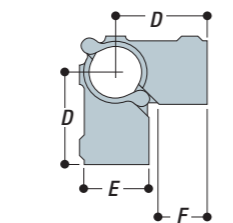
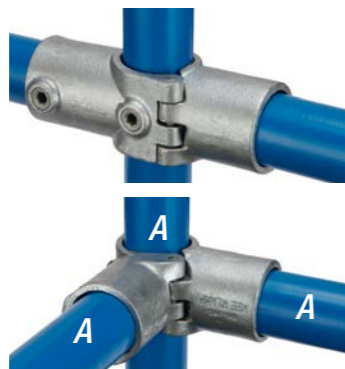

TYPE	Tube ref.	mm	Kg
A21/A26-8	A	D E F	1.17

25

Three Socket Tee

The Three Socket Tee will join three tubes together in a 90° perpendicular joint. The two set screws in the sleeve will allow two tubes to be coupled together. This component is most commonly used between the top-rail and an intermediate upright on safety railing.

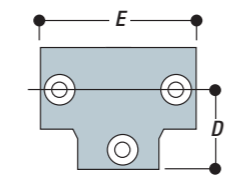
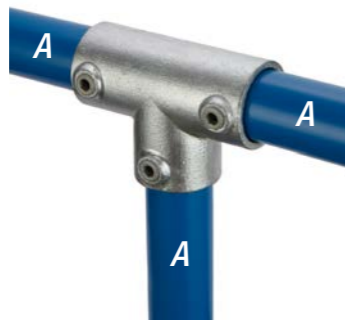

TYPE	Tube ref.	mm	Kg
25-4	A	D E	0.18
25-5	5	41 82	0.37
25-6	6	46 92	0.49
25-7	7	60 120	0.85
25-8	8	68 136	0.98
25-9	9	84 168	1.57

26

Two Socket Cross

Usually paired with Type 25 to give a 90° joint between the middle rail and an intermediate upright on safety railing. The upright passes through the component.

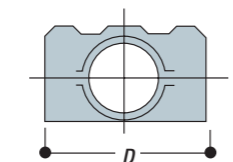
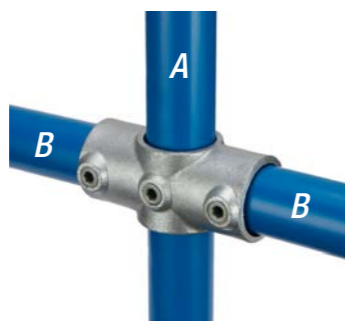

TYPE	Tube ref.	mm	Kg
26-4	A B	D	0.13
26-5	5 5	81	0.27
26-6	6 6	92	0.40
26-7	7 7	120	0.65
26-8	8 8	136	0.71
26-87	8 7	126	0.67
26-9	9 9	172	1.46

29

Single Socket Tee (30°-60°)

Designed as an alternative to Type 12, this adjustable component is most frequently used for bracing and struts. It may be used at any angle between 30° and 60°. See diagram on page 59.

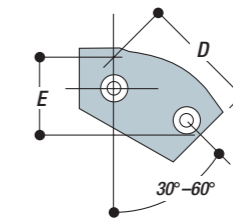
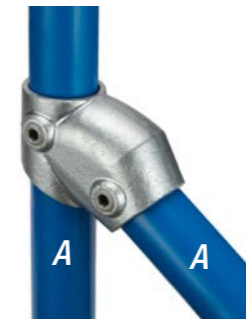

TYPE	Tube ref.	mm	Kg
29-6	A	D E	0.44
29-7	7	89 74	0.63
29-8	8	102 68	0.71

30

Adjustable Cross (30°-45°)

This adjustable component can be used for railing on staircases between the mid-rail and an intermediate upright which is required to remain vertical. It may be used at any selected angle between 30° and 45°.

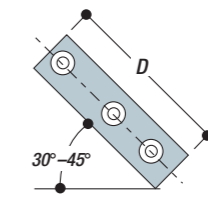
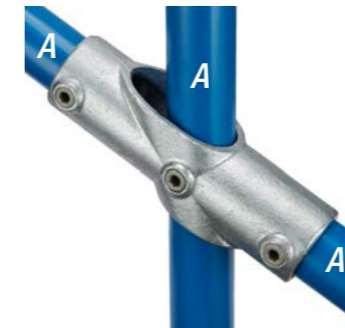

TYPE	Tube ref.	mm	Kg
30-6	A	D	0.64
30-7	7	178	0.97
30-8	8	216	1.30

31

Pallet Flange

This component has been designed for the construction of post pallets. Incorporates sockets for the upright and side tubes, and a locating bell for stacking pallets. (Special order only.)

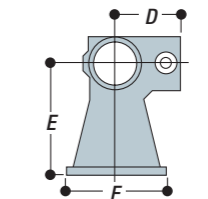

TYPE	Tube ref.	mm	Kg
31-8	A	D E F	1.80

32

Decorative Ball

Our Decorative Ball cap is an aesthetic component suitable for handrails used for pedestrian traffic and municipal areas. The component also serves a functional purpose in discouraging skateboarders and other pedestrian traffic from sliding across a railing.

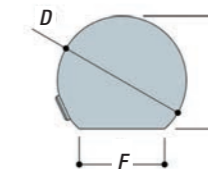

TYPE	Tube ref.	mm	Kg
32-7	A	D E F	0.67
32-8	7	80 70 53	1

35

Three Socket Cross

Most frequently used to connect uprights with horizontal tubes in three directions, all at 90° to the upright. The upright passes through the component.

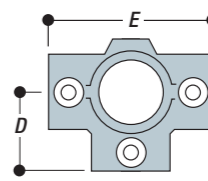
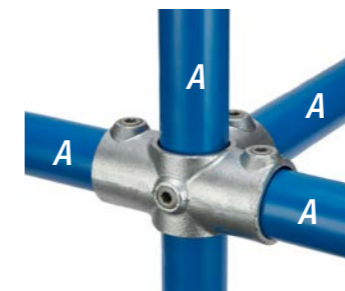

TYPE	Tube ref.	mm	Kg
35-4	A	D E	0.20
35-5	5	41 82	0.35
35-6	6	46 92	0.45
35-7	7	60 120	0.77
35-8	8	68 136	0.93
35-9	9	85 170	1.68

Kee Lite aluminium version available

A35

Split Three Socket Cross

The hinge and pin system of this component enables existing structures to be easily extended without the need for dismantling. This component has been designed to connect an upright with horizontal tubes in three directions, all at 90° to the upright. The upright passes through the component.

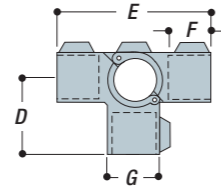
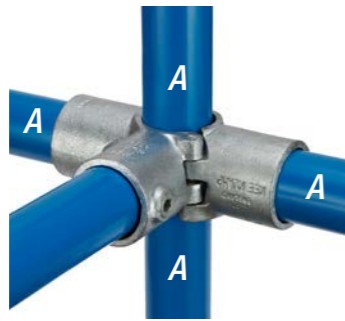

TYPE	Tube ref.		mm				Kg
	A	D	E	F	G		
A35-8	8	88	176	55	60	1.57	

40

Four Socket Cross

Most frequently used in multiple upright structures to tie a centre upright with horizontal tubes in four directions. The upright passes through the component.

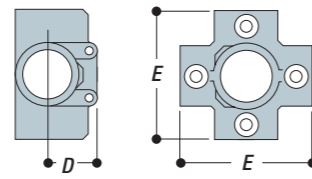
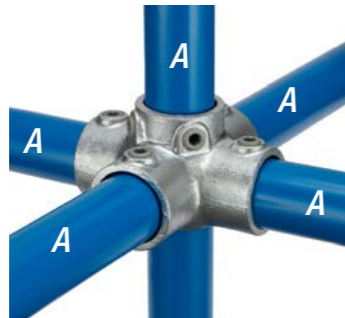

TYPE	Tube ref.		mm		Kg
	A	D	E		
40-4	4	34	67	0.27	
40-5	5	32	82	0.40	
40-6	6	37	92	1.01	
40-7	7	43	120	1.29	
40-8	8	53	136	1.90	
40-9	9	62	168	2.04	

A40

Split Four Socket Cross

The hinge and pin system of this component enables existing structures to be easily extended without the need for dismantling. This component is most frequently used in multiple upright structures to tie a centre upright with horizontal tubes in four directions. The upright passes through the component.

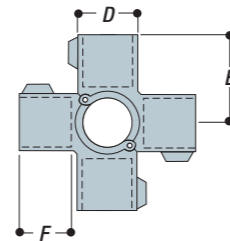
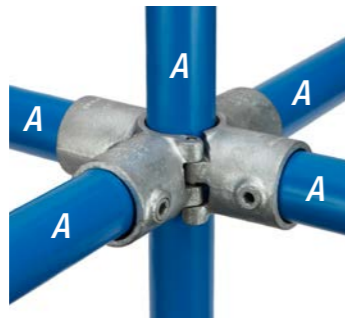

TYPE	Tube ref.		mm			Kg
	A	D	E	F		
A40-8	8	60	88	55	1.82	

45

Crossover

Designed to create a 90° crossover joint. Frequently used to minimise tube cuts and create a continuous horizontal for safety railing. It may also be used to create intermediate levels on racks, when horizontal connections between uprights are not required.

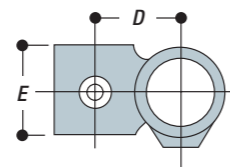
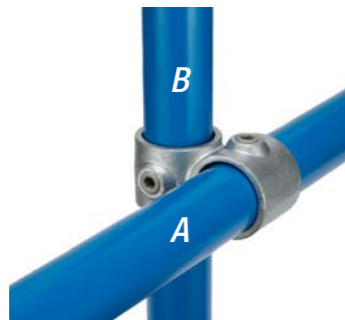

TYPE	Tube ref.		mm			Kg
	A	B	D	E		
45-3	3	3	21	25	0.07	
45-4	4	4	25	28	0.15	
45-5	5	5	34	31	0.20	
45-6	6	6	40	38	0.34	
45-65	6	5	36	41	0.29	
45-7	7	7	55	46	0.48	
45-76	7	6	45	46	0.45	
45-8	8	8	55	50	0.59	
45-86	8	6	48	51	0.45	
45-87	8	7	51	51	0.55	
45-9	9	9	67	61	0.91	
45-98	9	8	60	75	1.09	

A45

Split Crossover

The unique hinge and pin system of this component enables existing structures to be easily extended without the need for dismantling. This component is designed to give a 90° offset crossover joint. Tube should not be joined within the component. Type A45 function is comparable to Type 45 component.

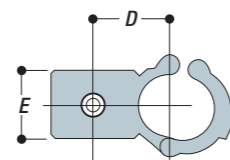
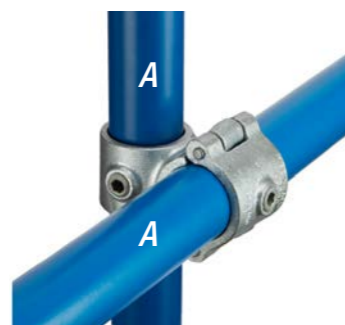

TYPE	Tube ref.		mm		Kg
	A	D	E		
A45-7	7	49	46	0.65	
A45-8	8	55	50	0.79	

46

Combination Socket Tee and Crossover

Used on racking to join horizontal carrying rails to the upright, leaving the socket to take a horizontal tie across the section. For shelved racking it is usual to have the horizontal tube outside the upright. On pallet racking it is preferable to have the carrying rails inside the upright.

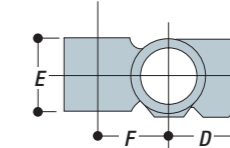
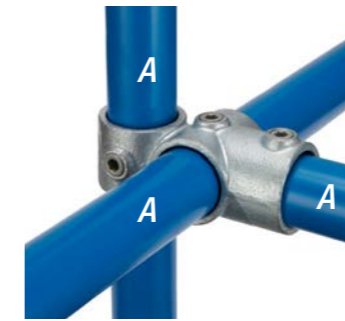

TYPE	Tube ref.		mm			Kg
	A	D	E	F		
46-4	4	34	28	25	0.15	
46-5	5	41	31	34	0.30	
46-6	6	46	38	40	0.49	
46-7	7	60	46	49	0.69	
46-8	8	68	51	55	0.91	
46-9	9	85	61	67	1.37	

Swivel Components

Types F50, M50, MH50, M51, MH51, M52, M53 and M58 are known as swivel components and can be assembled as Types C50, CH50, C51, C52, C53 and C58, or supplied as separate items. They are frequently used for bracing but can also overcome problems where joints are required at angles other than those achieved by fixed angle components. For economical use of tubing, when making 'C' components, or combination components, Types F50 (sizes 5 to 9 only) can be combined with different sizes of Types M50, MH50, M51, MH51, M52, M53 and M58. F50-4 and M50-4 will only combine with each other.

WARNING: An entire structure should not be constructed from swivel components, as they would not provide sufficient stability or rigidity in the structure. Types M50, MH50, M51, M52, M53 and M58 can also be used separately to secure various types of in-fill panel. These components are not designed to take bending moments.

C50

Single Swivel Socket

This complete combination component creates a range of 170°. See Types F50 and M50 for individual component specifications. See the 'Swivel Components' box for more information.

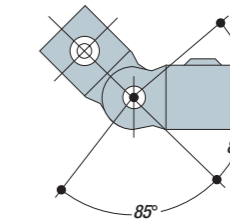
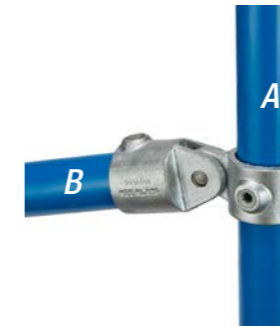

TYPE	Tube ref.		Kg
	A	B	
C50-44	4	4	0.15
C50-55	5	5	0.56
C50-66	6	6	0.64
C50-77	7	7	0.80
C50-88	8	8	0.91
C50-99	9	9	1.22

F50

Female Single Swivel Socket Member

One part of combination component C50. The Type F50 in size 4 has only one ear, while Type F50 in sizes 5 to 9 has two ears.

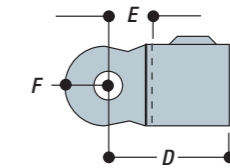

Note: Type F50-4 will only mate with a Type M50-4.

TYPE	Tube ref.	mm				Kg
		D	E	F	∅	
F50-4	4	38	14	11	6.5	0.07
F50-5	5	60	25	19	10	0.28
F50-6	6	60	21	19	10	0.34
F50-7	7	68	21	19	10	0.42
F50-8	8	76	25	19	10	0.52
F50-9	9	83	21	19	10	0.65

∅ indicates the diameter of the fixing hole.

M50

Male Single Swivel Socket Member

One part of combination component C50. This can also be used for attaching flat panels to tubular structures.

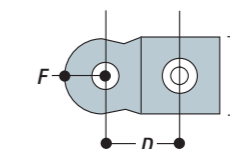

Note: Type M50-4 will only mate with a Type F50-4.

TYPE	Tube ref.	mm				Kg
		D	E	F	∅	
M50-4	4	28	20	11	6.5	0.06
M50-5	5	40	38	19	10	0.24
M50-6	6	43	38	19	10	0.27
M50-7	7	48	38	19	10	0.36
M50-8	8	54	47	19	10	0.36
M50-9	9	62	45	19	10	0.54

∅ indicates the diameter of the fixing hole.

Kee Lite aluminium version available

MH50

Male Single Horizontal Swivel Socket Member

This component can be used for attaching flat panels to tubular structures. Specially designed for retail shelving applications. Can also be used as part of a Type CH50 combination component.

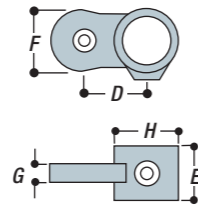

TYPE	Tube ref.	mm							Kg
		A	D	E	F	G	H	Ø	
MH50-6	6	43	38	38	11	46	10	0.30	

Ø indicates the diameter of the fixing hole.

P50

Single Offset Panel Tab

Designed for the securing of various types of panels and flooring to tube structures (i.e. plywood, plastic sheeting, wood planking, etc.). This component has one offset flange to allow the flush attachment of panels to tube. Often used with Type P51. See also Type P57.

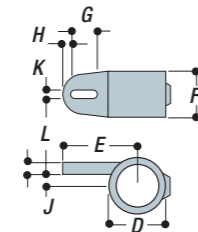

TYPE	Tube ref.	mm								Kg
		A	D	E	F	G	H	J	K	
P50-8	8	61	80	47	32	8	10	11	13	0.48

C51

Double Swivel Socket

This complete combination component creates a range of 170° on both sides of the upright. Type C51 is made by combining two Type F50 components and one Type M51. For dimensions refer to Type F50 and Type M51. See the 'Swivel Components' box for more information.

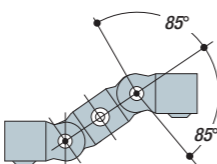
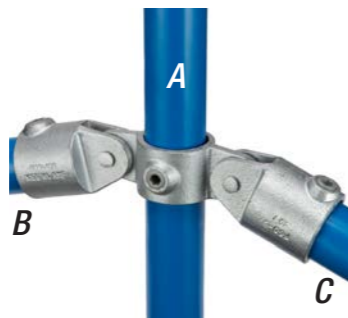

TYPE	Tube ref.	mm			Kg
		A	B	C	
C51-555	5	5	5	0.87	
C51-666	6	6	6	1.11	
C51-777	7	7	7	1.35	
C51-888	8	8	8	1.57	
C51-999	9	9	9	2.06	

M51

Male Double Swivel Socket Member

One part of a Type C51 combination component. This component can also be used for attaching flat panels to tubular structures.

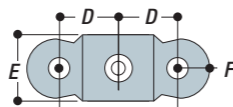

TYPE	Tube ref.	mm				Kg
		A	D	E	F	
M51-5	5	40	38	19	10	0.33
M51-6	6	43	38	19	10	0.38
M51-7	7	48	45	19	10	0.46
M51-8	8	54	45	19	10	0.48
M51-9	9	62	52	19	10	0.71

Ø indicates the diameter of the fixing hole.

MH51

Male Double Horizontal Swivel Socket Member

This component can be used for attaching flat panels to tubular structures. Specially designed for retail shelving applications, the MH51 can be used as part of a CH51 combination component.

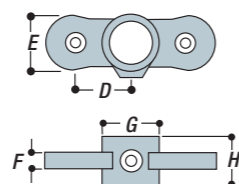

TYPE	Tube ref.	mm						Kg
		A	D	E	F	G	H	
MH51-6	6	43	38	11	46	38	10	0.44

Ø indicates the diameter of the fixing hole.

P51

Double Offset Panel Tab

Designed for the secure component of various types of panels and flooring to tube structures (i.e. plywood, plastic sheeting, wood planking, etc.) This component has two offset flanges to allow the flush attachment of panels to tube.

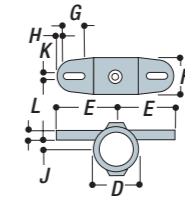

TYPE	Tube ref.	mm								Kg
		A	D	E	F	G	H	J	K	
P51-8	8	61	81	47	32	8	10	11	13	0.59

C52

Corner Swivel Socket

Complete combination component. Reducing combinations of Type C52 are available sizes 5 to 8. For dimensions refer to Type F50 and Type M52. See the 'Swivel Components' box for more information.

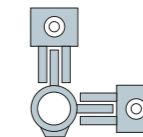
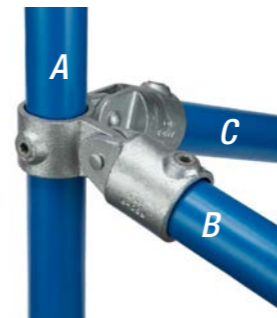

TYPE	Tube ref.	mm			Kg
		A	B	C	
C52-555	5	5	5	0.97	
C52-666	6	6	6	1.12	
C52-777	7	7	7	1.34	
C52-888	8	8	8	1.55	

M52

Male Corner Swivel Socket Member

One part of a Type C52 combination component. This can also be used for attaching flat panels to tubular structures.

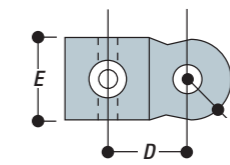

TYPE	Tube ref.	mm				Kg
		A	D	E	F	
M52-5	5	40	38	19	10	0.37
M52-6	6	43	38	19	10	0.39
M52-7	7	50	45	19	10	0.45
M52-8	8	54	47	19	10	0.46

Ø indicates the diameter of the fixing hole.

BC53

Swivel Elbow

Type BC53 component has been designed as a variable angle in-line connection, adjustable through 272°.

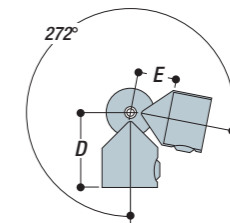

TYPE	Tube ref.	mm		Kg
		D	E	
BC53-66	6	60	33	0.51
BC53-77	7	73	36	0.81
BC53-88	8	83	45	1.14

WARNING: An entire structure should not be constructed from Type BC53-88 or any other swivel component, as these would not provide sufficient stability or rigidity in the structure due to the free rotation of the component.

C53

Adjustable Three Way Swivel Socket

Complete combination component. Type C53 is made by combining two Type M53 and two Type F50 components. For dimensions refer to Type F50 and type M53. See the 'Swivel Components' box for more information.

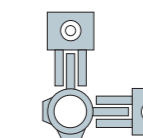
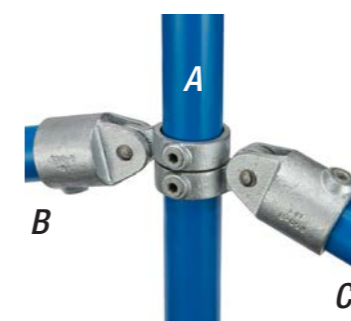

TYPE	Tube ref.	mm				Kg
		A	B	C	Ø	
C53-888	8	8	8	10.5	1.54	

Ø indicates the diameter of the fixing hole.

Kee Lite aluminium version available

M53

Variable Angle Double Swivel Socket Member

A part of a Type C53 combination component. Type C53 is made by combining two Type M53 and two Type F50 components.

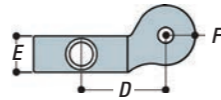

TYPE	Tube ref.	mm					Kg
		A	D	E	F	Ø	
M53-8	8	54	23	19	10.5	0.25	

Ø indicates the diameter of the fixing hole.

55

Obtuse Angle Elbow

The Type 55 is an ideal component to use as an alternative to bending, or when a junction between a sloping tube and an end post is required, i.e. guardrail and staircases. (Refer to page 59 for more information.)

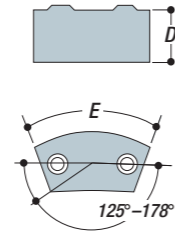

TYPE	Tube ref.	mm			Kg
		A	D	E	
55-6	6	46	116	0.51	
55-7	7	55	154	0.81	
55-8	8	60	153	0.85	

55A

Variable Elbow (11°-30°)

The Type 55A is an ideal component to use as an alternative to bending or when a junction between a sloping tube and an end post is required.

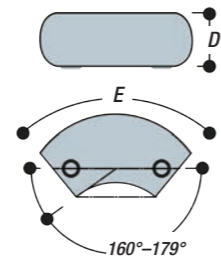

TYPE	Tube ref.	mm		Kg
		A	E	
55A-7	7	55	115	1.00
55A-8	8	60	150	1.28

56

Acute Angle Elbow (30°-45°)

Type 56 is an ideal component to use as an alternative to bending, or when a junction between a sloping tube and an end post is required, i.e. guardrail and staircases. (Refer to page 59 for more information.)

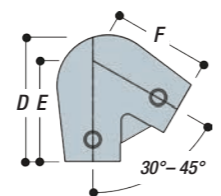
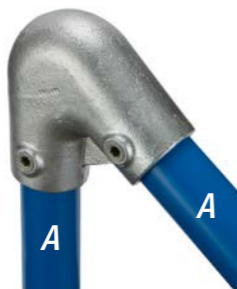

TYPE	Tube ref.	mm			Kg
		A	D	F	
56-7	7	105	99	99	0.98
56-8	8	134	112	112	1.29

56A

Acute Angle Elbow (11°-30°)

Type 56A is an ideal component to use as an alternative to bending, or when a junction between a sloping tube and an end post is required i.e. guardrail on staircases between 11° and 30°.

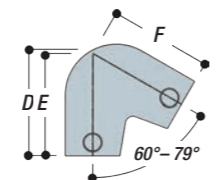
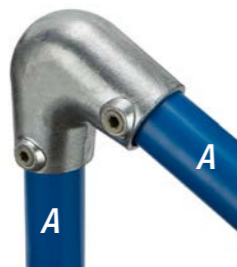

TYPE	Tube ref.	mm			Kg
		A	D	F	
56A-7	7	120	108	108	0.94
56A-8	8	125	112	112	1.12

P57

Single Panel Tab

Designed for the securing of various types of panels and flooring to tube structures (i.e. plywood, plastic sheeting, wood planking, etc.). This component has a single offset flange to allow for the attachment of panels to tube. See Type P50.

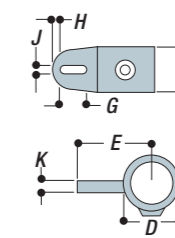

TYPE	Tube ref.	mm							Kg
		A	D	E	F	G	H	J	
P57-8	8	61	77.5	32	22.5	9	10	11	0.30

P57E

Single Extended Panel Tab

This component is similar to the P57-8 but has an elongated offset flange with a fixing hole rather than a slot.

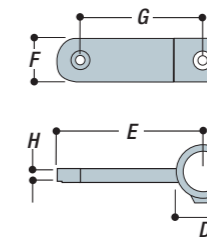

TYPE	Tube ref.	mm					Kg	
		A	D	E	F	H		
P57E-7	7	55	103	32	86	11	6	0.37

Ø indicates the diameter of the fixing hole.

C58

Swivel Flange

A swivel component for attachment of angled tubing to a flat surface. For dimensions refer to Type F50 and Type M58.

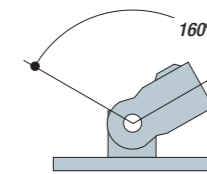

TYPE	Tube ref.	Kg
C58-5	5	0.70
C58-6	6	0.76
C58-7	7	0.84
C58-8	8	0.94
C58-9	9	0.98

WARNING: C58 is not recommended for use as a base flange to support guardrail, balustrades or other types of structure.

M58

Swivel Flange Plate

This component may be considered for various wall and brace fixings. It is often combined with Type F50 to give an adjustable angle component Type C58. The diameter of the attachment bolt hole is 10mm.

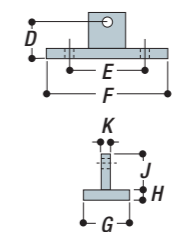

TYPE	mm							Kg	
	D	E	F	G	H	J	K		
M58	35	84	112	51	6	45	9	11	0.37

Ø indicates the diameter of the fixing hole.

P58

Double Extended Panel Tab

This component is designed for securing various types of panels and flooring to tubular structures. It has central flanges with fixing holes.

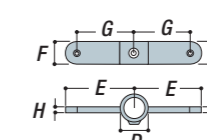
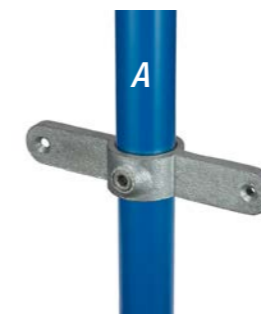

TYPE	Tube ref.	mm					Kg	
		A	D	E	F	H		
P58-7	7	55	103	32	86	11	6	0.56

Ø indicates the diameter of the fixing hole.

59

Spigot Flange

A spigot flange which fits inside the tube and is not secured by a socket screw. Type 59 can only be used with a tube wall thickness of 3.2 mm and in light, self supporting structures.

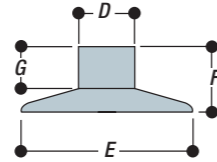

Note: No fixing holes are provided in this component.

TYPE	Tube ref.	mm					Kg
		A	D	E	F	G	
59-5	5	18	81	28	18	0.33	
59-6	6	24	87	32	22	0.40	
59-7	7	32	98	35	25	0.60	
59-8	8	38	103	41	30	0.85	
59-9	9	49	110	48	36	1.00	

60

Extra Heavy Flange

Heavy duty flange with wide base for spreading loads over a large surface area. Holes provided for countersunk flat head screw fixings only. For use on structures where the fixing required is positional only. Frequently used as a wall fixing bracket (refer to table on page 63).

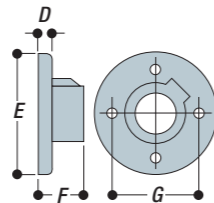
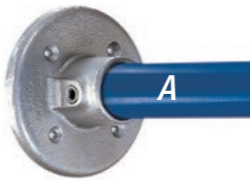

TYPE	Tube ref.	mm						Kg
		A	D	E	F	G	Ø	
60-5	5	14	130	64	79	8	0.89	
60-6	6	14	140	64	86	8	1.15	
60-7	7	14	149	64	95	8	1.30	
60-8	8	14	156	64	102	8	1.48	

Ø indicates the diameter of the fixing hole.

WARNING: This component is not recommended for use as a base flange to support guardrail or balustrades (see Type 62).

61

Flange

Frequently used as a wall fixing bracket (refer to table on page 63). Used on structures where the fixing required is positional only. Holes provided for countersunk flathead screw fixings only.

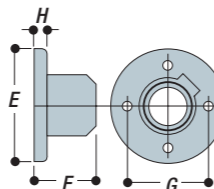

TYPE	Tube ref.	mm						Kg
		A	E	F	G	H	Ø	
61-3	3	70	32	47	6	6.5	0.19	
61-4	4	76	39	54	6	6.5	0.23	
61-5	5	80	40	57	6	6.5	0.33	
61-6	6	90	48	64	6	6.5	0.50	
61-7	7	102	51	76	7	6.5	0.44	
61-8	8	114	59	89	8	6.5	0.67	
61-9	9	127	63	95	10	10	1.08	

Ø indicates the diameter of the fixing hole.

WARNING: This component is not recommended for use as a base flange to support guardrail or balustrades (see Type 63).

62

Standard Railing Flange

Ideal when a structural fixing is required for guard rail and balustrades. The holes are of sufficient diameter to ensure proper fixing with either a mechanical or chemical anchor. The two set screws in the vertical socket give greater side-load stability to the upright. It is recommended that the fixing holes in the flange should be in line with the applied load (refer to table on page 63).

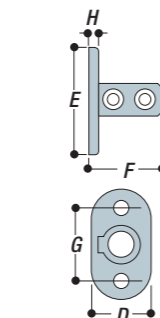
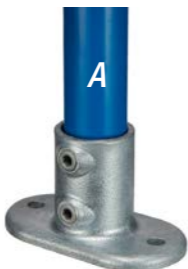

TYPE	Tube ref.	mm						Kg
		A	D	E	F	G	H	
62-5	5	64	116	76	76	8	11	0.59
62-6	6	76	128	89	89	8	14	0.73
62-7	7	75	140	89	102	10	14	0.97
62-8	8	85	155	89	115	10	14	1.12
62-9	9	102	165	127	10	18	1.76	

Ø indicates the diameter of the fixing hole.

63

Angle Base Flange (45°-60°)

Similar to Type 62, but used to set up the upright at an angle between 45° to 60°. This component should only be subjected to light loads which cannot be positioned at 90° to the applied load. For greater loads or other tube sizes, a Type 62 flange is used and the upright bent to the required angle (refer to table on page 63).

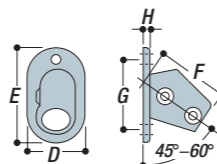

TYPE	Tube ref.	mm						Kg
		A	D	E	F	G	H	
63-6	6	76	127	92	95	8	14	0.91
63-7	7	76	138	95	106	10	14	1.17
63-8	8	89	155	100	115	10	14	1.53

Ø indicates the diameter of the fixing hole.

64

Standard Vertical Railing Flange

For fixing guardrail and balustrades to walls, parapets, steps, and ramps. The upright cannot drop through the socket. The max. length of top bolt (inc. the head) must not exceed 25mm, also applies to projecting fixed studs (refer to table on page 63).

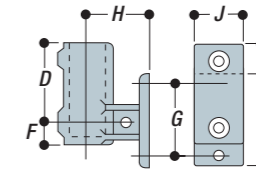

Note: Should an upright be required to pass through the component, the base can be bored out to order.

TYPE	Tube ref.	mm								Kg
		A	D	E	F	G	H	J	K	
64-6	6	86	95	22	67	57	45	39	14	0.77
64-7	7	84	108	30	72	64	50	30	14	1.12
64-8	8	89	121	32	89	70	58	28	14	1.54

Ø indicates the diameter of the fixing hole.

*Refer to table on page 63.

65

Standard Horizontal Railing Flange

This component is designed for palm fixing guardrailing and balustrading to walls, parapets, steps and ramps. The upright cannot drop through the socket (refer to table on page 63).

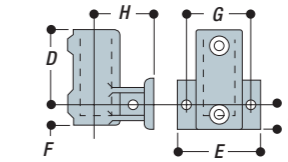

Note: Should an upright be required to pass through the component, the base can be bored out to order.

TYPE	Tube ref.	mm								Kg
		A	D	E	F	G	H	J	K	
65-6	6	83	96	22	67	57	22	14	0.88	

Ø indicates the diameter of the fixing hole.

66

Ground Socket

A ground socket component for setting in concrete. The posts may either be permanent or removable as required. It incorporates a socket set screw fixing and can be supplied with a plug to fill the hole when the tube is removed (refer to table on page 63).

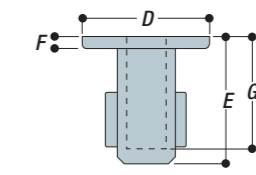

TYPE	Tube ref.	mm					Kg
		A	D	E	F	G	
66-6	6	127	122	10	115	1.87	
66-7	7	140	135	10	127	1.44	
66-8	8	140	135	10	127	1.43	

67

Angle Flange

Type 67 has been designed to allow the upright to pivot in the barrel, providing an angular displacement from 3° up to a maximum of 11°, measured from the vertical. Ideal to secure balustrade and guardrail systems on access ramps or other types of slopes (refer to table on page 63).

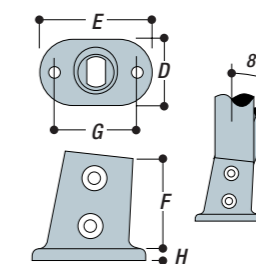

Note: It is generally recommended that, when installing the 67-8, the fixing holes in the base should be in line with the applied load.

TYPE	Tube ref.	mm						Kg
		A	D	E	F	G	H	
67-7	7	83	140	79	102	10	14	1.13
67-8	8	96	155	80	115	10	14	1.30

Ø indicates the diameter of the fixing hole.

68

Wall Flange

Side fixing for guardrailing and balustrading to walls, parapets, steps and ramps. The upright cannot drop through the socket (refer to table on page 63).

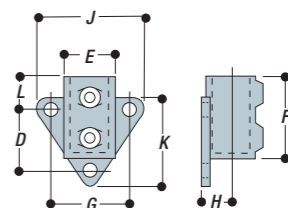

Note: If the upright is required to pass through the component by machining out the base stop, the bottom fixing hole will be unusable.

TYPE	Tube ref.	mm									Kg
		A	D	E	F	G	H	J	K	L	
68-6	6	63	45	77	71	24	96	88	25	11	0.62
68-7	7	72	55	83	83	28	108	97	25	11	0.80
68-8	8	78	60	89	86	31	111	103	25	11	0.87

Ø indicates the diameter of the fixing hole.

69

Railing Flange with Toeboard Adaptor

For guardrail and balustrade applications with added toeboard at base. Base plate holes have sufficient diameter to allow for attachment with either a mechanical or chemical anchor. Side plates have slotted holes to allow for a degree of sideways movement for ease of installation (refer to table on page 54).

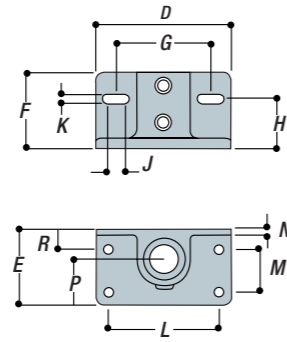

TYPE	Tube ref.	mm							Kg
		D	E	F	G	H	J	K	
69-6	6	130	75	89	95	58	15	10	1.62
		L	M	N	P	R	Ø		
		100	35	7	45	25	11		
69-7	7	145	80	90	97	58	20	10	1.87
		L	M	N	P	R	Ø		
		115	40	7	47	25	11		
69-8	8	160	90	90	112	58	20	10	2.30
		L	M	N	P	R	Ø		
		130	50	7	54	25	11		

Ø indicates the diameter of the fixing hole.

70

Rail Support

Designed to carry handrails along walls or to fix structures back to walls. The tube passes through the component and cannot be used as a coupling. The Type 70 is also used to attach toeboards to the base of guardrail uprights. Holes provided for countersunk flat head screw fixings only.

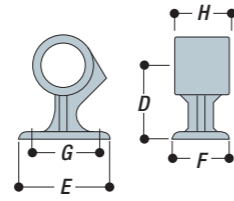

TYPE	Tube ref.	mm							Kg
		A	D	E	F	G	H	Ø	
70-5	5	54	76	46	57	30	8	0.36	
70-6	6	57	82	44	63	30	8	0.46	
70-7	7	63	102	44	76	34	8	0.57	
70-8	8	67	108	48	85	34	8	0.62	

Ø indicates the diameter of the fixing hole.

WARNING: Type 70 components are not designed to be used as base flanges for full height guardrails or handrails.

71

Weather Cap

Designed for roof guardrailing to ensure a weathertight seal for base flanges. The weather cap is secured to the upright by means of a combined sealant adhesive. A separate information sheet detailing fixing instructions is available on request.

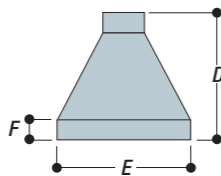

TYPE	Tube ref.	mm			Kg
		A	D	E	
71-6	6	125	143	25	0.24
71-7	7	150	154	25	0.32
71-8	8	155	167	25	0.36

Ø indicates the diameter of the fixing hole.

72

Stair Tread Support

Suitable for most types of stair tread, including timber, open steel and checker plate. Fixing of the tread is by two bolt holes in each component.

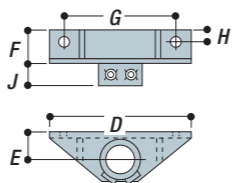

TYPE	Tube ref.	mm							Kg
		A	D	E	F	G	H	J	
72-8	8	203	39	51	153	20	33	12	1.25

Ø indicates the diameter of the fixing hole.

WARNING: If Type 72 components are to be used for a permanent application or subjected to high loads, the stair tread support tube which is located at its ends with a single set screw, should be drilled and pinned to avoid rotational slip.

75

Collar

Commonly used to support another component if the latter is required to be left untightened, such as gate hinges. Type 75 also provides additional support when the loading on a structure exceeds the maximum permitted slip load for a socket set screw.

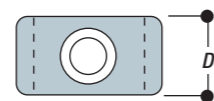

TYPE	Tube ref.	mm		Kg
		A	D	
75-4	4	22	0.05	
75-5	5	25	0.09	
75-6	6	26	0.13	
75-7	7	25	0.15	
75-8	8	25	0.19	

Ø indicates the diameter of the fixing hole.

76

Hook

A component normally used for attachment of chains.

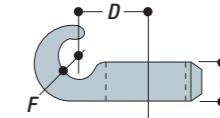

77

Plastic Plug

A grey plastic plug to fit open ended tubes. Suitable for medium and heavy tubing only. For an alternative in metal, see Type 84.



78

Eye Fitting

Used in conjunction with Type 83 component for gate hinges.

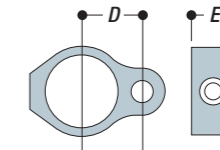

TYPE	Tube ref.	mm			Kg
		A	D	E	
78-5	5	30	25	14	0.21
78-6	6	33	26	14	0.25
78-7	7	38	26	14	0.26
78-8	8	41	26	14	0.28

Ø indicates the diameter of the fixing hole.

79

Sheeting Clip

This component is used to attach profiled sheeting material to tube. The component is supplied with the following hardware: one M6 x 50mm roofing bolt, one M6 square nut, and one M6 lock washer. BZP finish.

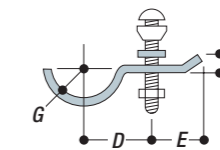

TYPE	Tube ref.	mm					Kg
		A	D	E	F	G	
79-7	7	46	34	8	21	8	0.08

Ø indicates the diameter of the fixing hole.

81

Single Sided Clip

For attaching wire mesh infill. For economy, it is possible to use Type 81 clips without the safety attachment to secure various types of infill panels (plyboard, perspex, etc.) up to a thickness of 10mm. All clips are supplied with hexagonal head fixing bolts, M6 x 35mm long and nut. The primary clip has a slot measuring 8 x 15mm.

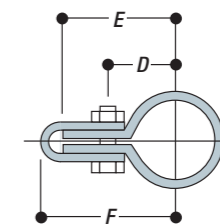
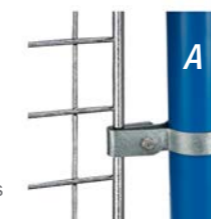

TYPE	Tube ref.	mm				Kg
		A	D	E	F	
81-5	5	24	39	56	7.5	0.07
81-6	6	27	42	59	7.5	0.08
81-7	7	32	47	64	7.5	0.08
81-8	8	34	49	66	7.5	0.09
81-9	9	40	55	72	7.5	0.10

Ø indicates the diameter of the fixing hole.

Note: For D and E dimensions the figures are given for the respective minimum and max. dimensions allowed by the slotted hole.

82

Double Sided Clip

For attaching wire mesh infill. For economy it is possible to use Type 82 clips without the safety attachment, to secure various types of infill panels (plyboard, perspex, etc.) up to a thickness of 10mm. All clips are supplied with hexagonal head fixing bolts, M6 x 35mm long, and nut. The primary clip has a slot measuring 8mm x 15mm.

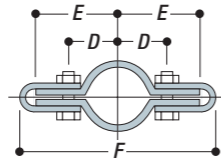
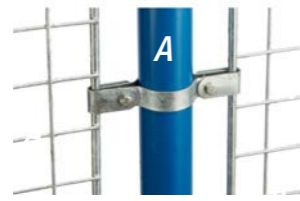

Note: For D and E dimensions the figures are given for the respective minimum and max. dimensions allowed by the slotted hole.

TYPE	Tube ref.	mm				Kg
		A	D	E	F	
82-5	5	24	39	112	7	0.11
82-6	6	27	42	118	7	0.12
82-7	7	32	47	128	7	0.13
82-8	8	34	49	132	7	0.14
82-9	9	40	55	144	7	0.14

∅ indicates the diameter of the fixing hole.

83

Pin Fitting

This component is used in conjunction with Type 78 for gate hinges.

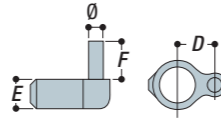
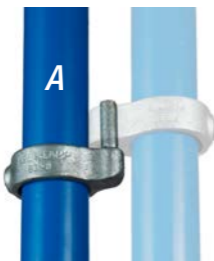

TYPE	Tube ref.	mm				Kg
		A	D	E	F	
83-5	5	30	26	38	13	0.20
83-6	6	33	25	38	13	0.25
83-7	7	38	25	38	13	0.29
83-8	8	41	26	38	13	0.30

∅ indicates the diameter of the fixing hole.

84

Malleable Plug

A metal drive-in plug which is difficult to remove when installed. For an alternative in plastic, see Type 77.

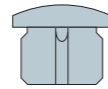

TYPE	Tube ref.	Kg
84-5	5	0.05
84-6	6	0.10
84-7	7	0.12
84-8	8	0.17
84-9	9	0.29

Note: This component can only be used with EN 10255 (ISO 65) medium weight tubing.

87

Angle Elbow (0°–11°)

Used to join the top-rail to an end upright on a guardrail on a slope from 0° to 11°.

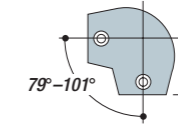

TYPE	Tube ref.	mm		Kg
		A	D	
87-7	7	60	0.70	
87-8	8	68	0.90	

88

Three Socket Angle Tee (0°–11°)

Used to join the top-rail to an intermediate upright on a guardrail on a slope from 0° to 11°. As there are two socket set screws in the sleeve, this component can be used to join two tubes.

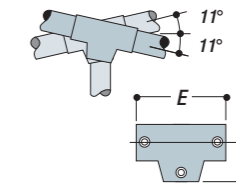
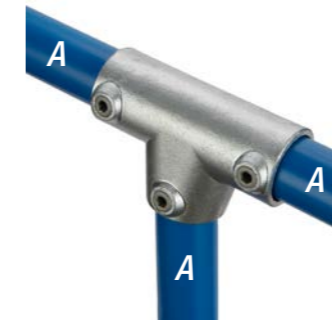

TYPE	Tube ref.	mm		Kg
		A	D	
88-7	7	60	1.02	
88-8	8	68	1.24	

89

Two Socket Angle Cross (0°–11°)

Used to join the middle rail to an intermediate upright on a guardrail on a slope from 0° to 11°. The upright passes through the component.

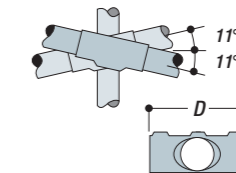
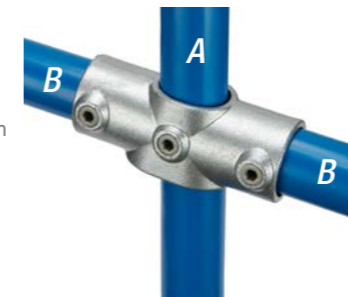

TYPE	Tube ref.	mm	Kg
89-7	7	144	0.70
89-8	8	158	0.85
89-87	8	155	0.76

The Slope Range (86-89)

The slope range of components consists of component Types 67, 86, 87, 88, 89. These components are designed to facilitate in-line railings with vertical posts on slopes with angles between 0° and 11°. They can be used to construct railings on access ramps for people with disabilities when used in conjunction with the Kee Klamp access range (see page 58).

The PGR Range (90–95)

These are known as Pedestrian Guardrail (PGR) components and are used as an alternative to Types 10, 15, 25 and 26 when the site is not straight and level. There is sufficient play within the component to negotiate a slope up to 7 degrees or a radius greater than 6 metres, when the uprights are 2 metre centres, using straight tube. They also allow damaged rails to be removed without dismantling the adjacent structure. The 90 to 95 range of components is available in size 8.

86

Angle Tee (0°–11°)

Used to join the middle rail to an upright on a guardrail on a slope from 0° to 11°.

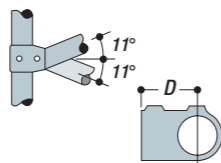
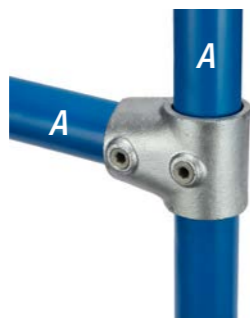

TYPE	Tube ref.	mm		Kg
		A	D	
86-7	7	60	0.55	
86-8	8	68	0.63	

90

PGR Three Socket Tee

Type 90 is used to join the top-rail to an intermediate upright.

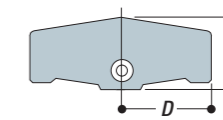

TYPE	Tube ref.	mm		Kg
		A	D	
90-8	8	99	1.56	

Kee Lite aluminium version available

91

PGR Two Socket Cross

Type 91 is used to join the mid-rail to an intermediate upright.

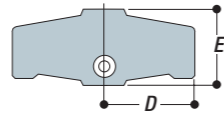
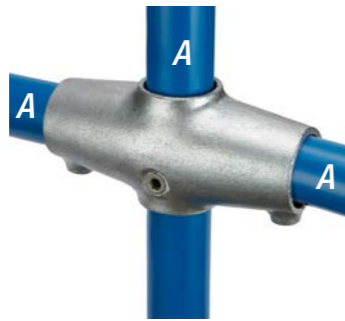

TYPE	Tube ref.	mm			Kg
	A	D	E		
91-8	8	99	89		1.48

92

PGR Elbow

Type 92 is used to join the top-rail to an end post.

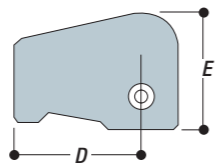
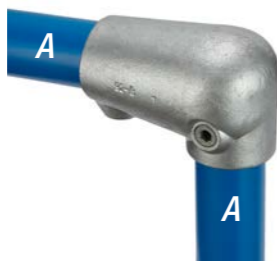

TYPE	Tube ref.	mm			Kg
	A	D	E		
92-8	8	99	89		1.29

93

PGR Tee

Type 93 is used to join the mid-rail to an end post.

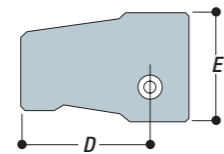
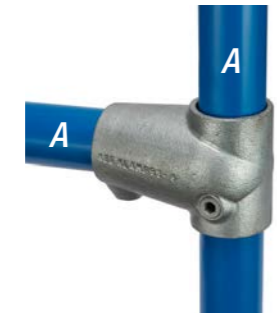

TYPE	Tube ref.	mm			Kg
	A	D	E		
93-8	8	99	89		1.20

95

PGR Internal Spigot

Internal spigot designed to prevent sagging of bends when using the 90 to 95 range of components.

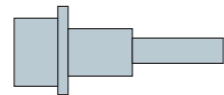

TYPE	Tube ref.	mm			Kg
	A	D	E		
95-8	8				0.46

105

Sheeting Clip without Hardware

This clip is used to attach profiled or flat sheeting. It is supplied with fixings.

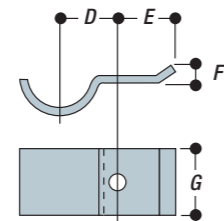

TYPE	Tube ref.	mm					Kg
	A	D	E	F	G	∅	
105-6	6	32	38	13	50	9	0.14
105-7	7	38	40	13	50	9	0.16
105-8	8	40	40	13	50	9	0.18
105-9	9	48	40	13	50	9	0.23

∅ indicates the diameter of the fixing hole.

Note: For use where fixing required is positional only. Clip is not intended to bear substantial load.

114

Swivel Tee

An internal swivel component, designed to accommodate varying angles on handrailing to staircases, ramps or bracing. Used in conjunction with Types 10, 15, 25 or 45.

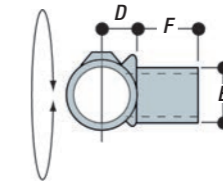

TYPE	Tube ref.	mm			Kg
	A	D	E	F	
114-6	6	23	33	29	0.36
114-7	7	27	42	36	0.47
114-8	8	30	49	41	0.58

115

Horizontal Railing Flange

Type 115 is designed for palm fixing of guardrail and balustrades to walls, parapets, steps and ramps. The upright cannot drop through the socket. Packer plates, Type S115, are available to allow the component to be positioned in channels, slots and other offset areas.

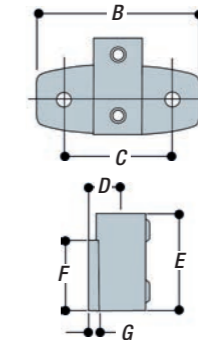
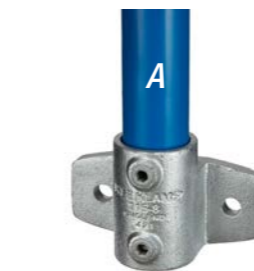

TYPE	Tube ref.	mm						Kg	
	A	B	C	D	E	F	G		∅
115-6	6	150	100	30	90	65	10	14	1.08
115-7	7	150	100	35	90	65	10	14	1.23
115-8	8	150	100	41	90	65	13	14	1.42

∅ indicates the diameter of the fixing hole.

S115

Packer Plate for Type 115

Type S115 allows the Type 115 component to be positioned in channels, slots and other offset areas.

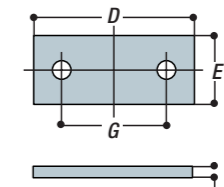

TYPE	mm					Kg
	D	E	F	G	∅	
S115	150	65	12	100	14	0.87

∅ indicates the diameter of the fixing hole.

118

Cover Flange

This component slips over uprights to finish below ground post installations. The component is secured to the upright tube with a single recessed set screw.

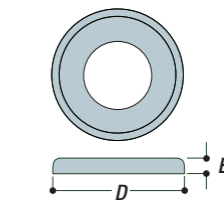

TYPE	Tube ref.	mm			Kg
	A	D	E		
118-8	8	100	15		0.40

121

Corner Crossover

This component is designed to provide a 90° offset corner joint. This components is typically used with the Type 45 and Type 145 crossover components to built and offset railing.

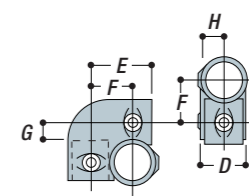
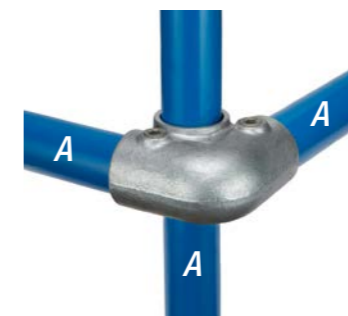

TYPE	Tube ref.	mm					Kg
	A	D	E	F	G	H	
121-7	7	55	72	49	22	28	0.92

Note: To obtain the true height of the upright the allowance for the base components must be included.

145

Crossover Coupling

Designed to give a 90° offset crossover. With two socket set screws in the sleeve, this Kee Klamp component can be used where a join is required in the horizontal tube.

For economy, it is possible to use a Type 45 in place of the 145, using the 145 only where a join in the tube occurs.

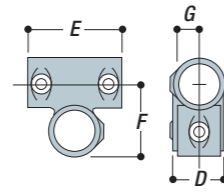
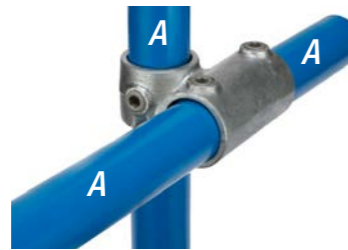

TYPE	Tube ref.		mm				Kg
	A	D	E	F	G		
145-7	7	55	72	49	22	0.92	

Note: To obtain the true height of the upright the allowance for the base components must be included.

199

Single Offset Fixing Bracket

The Type 199 is used as an attachment point for flat sheets or boards and comes supplied with a drilled hole.

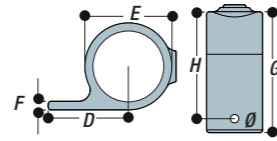

TYPE	Tube ref.		mm						Kg
	A	D	E	F	G	H	Ø		
199-6	6	45	73	5	60.5	25	8.5	0.27	
199-7	7	53	80.5	6	53	40	6	0.36	
199-8	8	56	86.5	6	56	40	6	0.36	

Ø indicates the diameter of the fixing hole.

200

Double Offset Fixing Bracket

The Type 200 is used as an attachment point for flat sheets or boards and comes supplied with a drilled hole.

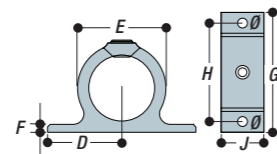

TYPE	Tube ref.		mm							Kg
	A	D	E	F	G	H	J	Ø		
200-6	6	45	45	5	90	70	25	6.5	0.18	
200-7	7	53	55	6	106	86	40	11.5	0.38	
200-8	8	56	66.7	6	112	92	40	11.5	0.59	

Ø indicates the diameter of the fixing hole.

262

Round Base Flange

The Round Base Flange features a single fixing hole. The hole is hidden to create a more aesthetic look. The two set screws in the vertical socket give greater upright stability.

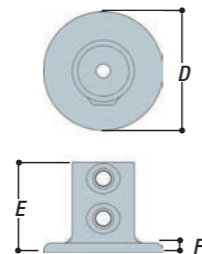

TYPE	Tube ref.		mm				Kg
	A	D	E	F	Ø		
262-8	8	116	89	10	14	0.96	

Ø indicates the diameter of the fixing hole.

265

Offset All Wall Flange

Side fixing for guardrail and balustrades to walls, parapets, steps and ramps. Upright cannot drop through the socket. Designed for installations of rail that are offset from which it is being fixed.

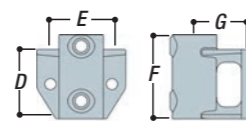
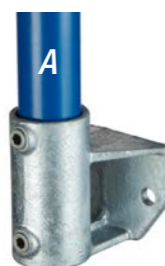

TYPE	Tube ref.		mm					Kg
	A	D	E	F	G	Ø		
265-7	7	86	76	104	66	14	1.35	
265-8	8	86	94	119	74	14	1.56	

Ø indicates the diameter of the fixing hole.

316

Parapet Flange

Designed to retrofit onto roof parapets that are at an unsafe height. Upright tube is angled 25 degrees from the vertical so that the building's visage is unaffected by the installed guardrailing. Two holes are located in the top mounting bracket for fixing directly into the parapet. The two set screws in the vertical socket give greater side-load stability to the angled upright. Engineered weep hole allows water to drain.

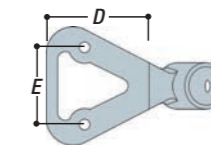

TYPE	Tube ref.		mm			Kg
	A	D	E	Ø		
316-7	7	170	100	14	1.88	
316-8	8	170	100	14	2.05	

Ø indicates the diameter of the fixing hole.

The Slope Range (320-427)

This slope range of components is designed specifically for use on steeper gradients and consists of component Types 320, 321, 325, 326, 427. These components are designed to facilitate in-line railings with vertical posts where the slope is greater than 30°.

320LH

Left hand level to Sloping Down Side Outlet Elbow (30°-45°)

Left Hand Side Outlet Elbow component designed for the top-rail on guardrail on slopes and staircases between 30° and 45° at the junction where the handrail changes from level to sloping down the stairs.

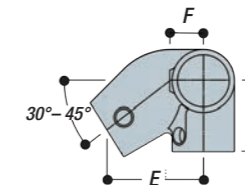

TYPE	Tube ref.		mm			Kg
	A	D	E	F		
320LH-7	7	86	60	29	1.08	
320LH-8	8	93	68	32	1.28	

Note: handing perspective for Kee Klamp is looking DOWN the staircase.

320RH

Right hand level to Sloping Down Side Outlet Elbow (30°-45°)

Right Hand Side Outlet Elbow component designed for the top-rail on guardrail on slopes and staircases between 30° and 45° at the junction where the handrail changes from level to sloping down the stairs.

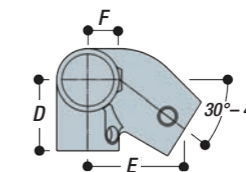
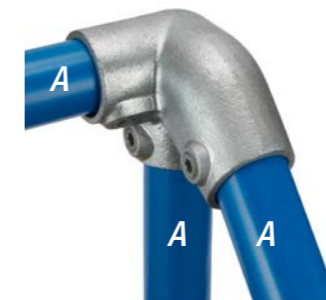

TYPE	Tube ref.		mm			Kg
	A	D	E	F		
320RH-7	7	86	60	29	1.08	
320RH-8	8	93	68	32	1.28	

Note: handing perspective for Kee Klamp is looking DOWN the staircase.

321LH

Left hand level to Sloping Down Side Outlet Tee (30°-45°)

Left Hand Side Outlet Tee component designed for the mid-rail on guardrail on slopes and staircases between 30° and 45° at the junction where the handrail changes from level to sloping down the stairs.

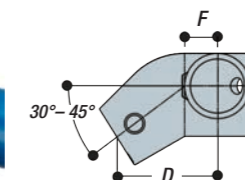
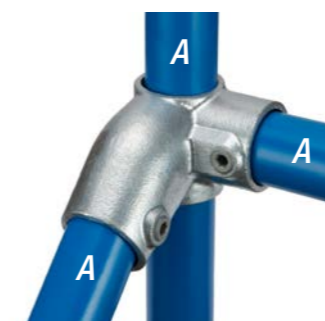

TYPE	Tube ref.		mm			Kg
	A	D	E	F		
321LH-7	7	86	27	29	0.96	
321LH-8	8	92	30	32	1.12	

Note: handing perspective for Kee Klamp is looking DOWN the staircase.

321RH

Right hand level to Sloping Down Side Outlet Tee (30°-45°)

Right Hand Side Outlet Tee component designed for the mid-rail on guardrail on slopes and stair-cases between 30° and 45° at the junction where the handrail changes from level to sloping down the stairs.

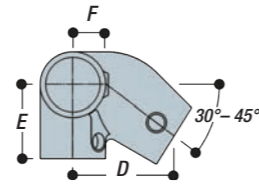
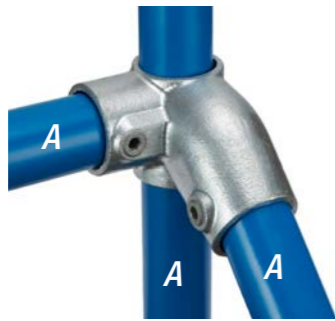

Note: handing perspective for Kee Klamp is looking DOWN the staircase.

TYPE	Tube ref.	mm			Kg
	A	D	E	F	
321RH-7	7	86	27	29	0.96
321RH-8	8	92	30	32	1.12

325

Level to Sloping Down Tee (30°-45°)

Tee component designed for the top-rail on guardrail on slopes and staircases between 30° and 45° at the junction where the handrail changes from level to sloping down the stairs.

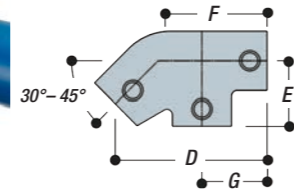
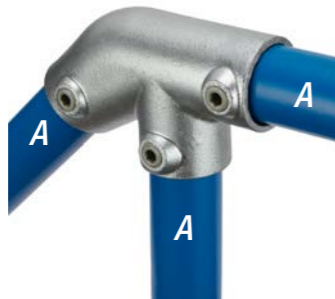

TYPE	Tube ref.	mm				Kg
	A	D	E	F	G	
325-7	7	142	60	89	60	1.02
325-8	8	154	68	100	68	1.12

325A

Level to Sloping Up Tee (30°-45°)

Tee component designed for the top-rail on guardrail on slopes and staircases between 30° and 45° at the junction where the handrail changes from level to sloping up the stairs.

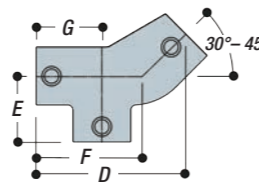
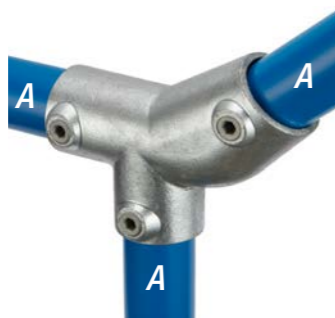

TYPE	Tube ref.	mm				Kg
	A	D	E	F	G	
325A-7	7	142	60	89	60	1.02
325A-8	8	155	68	100	68	1.12

326

Level to Sloping Down or Up Cross (30°-45°)

Level to Sloping Down or Up Cross (30°-45°) Cross component designed for the mid-rail on guardrail on slopes and staircases between 30° and 45° at the junction where the handrail changes from either level to sloping down or level to sloping up the stairs.

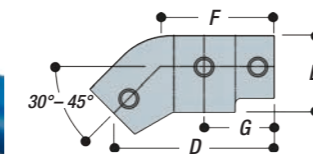
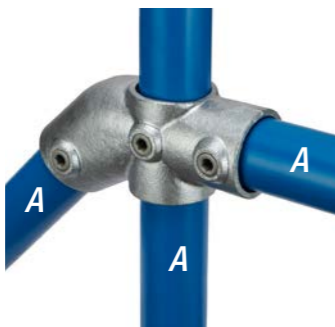

TYPE	Tube ref.	mm				Kg
	A	D	E	F	G	
326-7	7	142	68	89	60	0.82
326-8	8	154	74	100	68	0.95

327

Three Socket Tee (11°-30°)

This component is used on safety railing with slopes between 11°-30° and fixes the top-rail to a vertical intermediate upright.

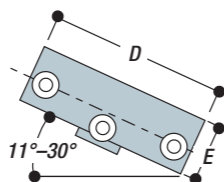
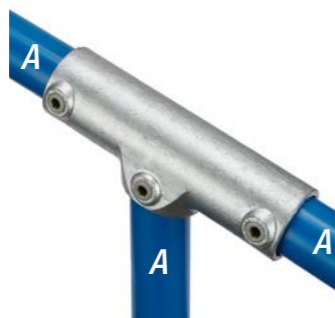

TYPE	Tube ref.	mm			Kg
	A	D	E		
327-7	7	180	55		1.10
327-8	8	216	60		1.40

328

Two Socket Cross (11°-30°)

This components is used on safety railing with slopes between 11°-30° and fixes the mid-rail to a vertical intermediate upright.

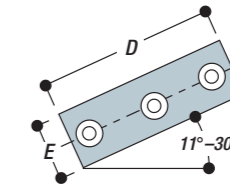
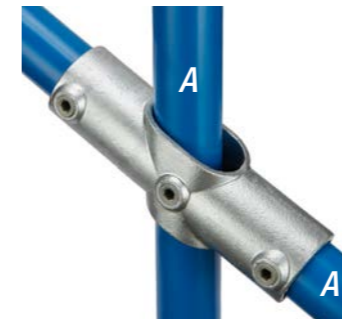

TYPE	Tube ref.	mm		Kg
	A	D	E	
328-7	7	180	55	1.07
328-8	8	216	60	1.20

329

Single Socket Tee (11°-30°)

Designed as an alternative to Type 12, this adjustable component is most frequently used for bracing and struts and for terminating the mid-rail on sloping guardrails into the end up-right. It may be used at any selected angle between 11° and 30°.

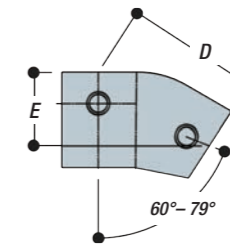
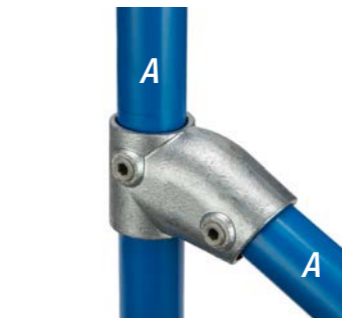

TYPE	Tube ref.	mm		Kg
	A	D	E	
329-7	7	99	54	0.73
329-8	8	109	59	0.86

350

Eaves Fitting

The Type 350 component has been designed for small structural building applications and provides for significant load rating. When used with the Type 351 ridge component a truss arrangement for additional support can be achieved. Double set screws are provided on the truss outlet to provide additional pull out resistance to hold structures firmly together.

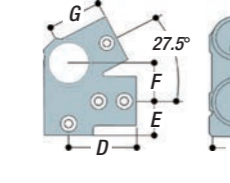
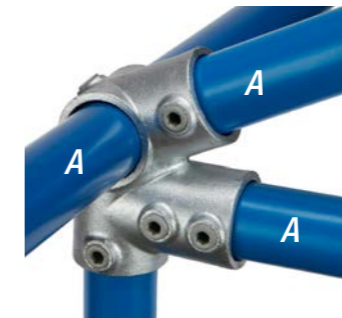

TYPE	Tube ref.	mm					Kg
	A	D	E	F	G	H	
350-8	8	83	42	47	67	60	1.24

351

Ridge Fitting

Designed for small structural building applications and provides for significant load rating. When used with the Type 350 eaves component a truss arrangement for additional support can be achieved. Double set screws are provided on the downward truss outlet to provide additional pull out resistance and extra strength to the structure.

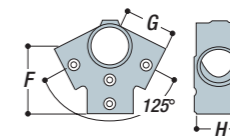
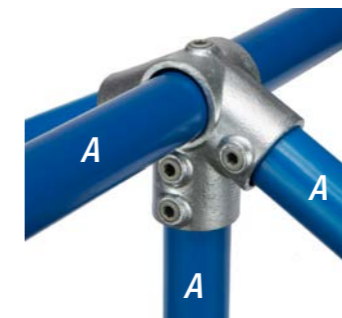

TYPE	Tube ref.	mm			Kg
	A	F	G	H	
351-8	8	89	67	60	0.92

363

Angle Base Flange (11°-30°)

Similar to a type 63, it is used to set the upright at an angle between 11°-30°. This component should only be subjected to light loads which cannot be positioned at 90° to the applied load. For greater loads or other tube sizes a Type 62 flange should be used with the upright bent to the required angle.

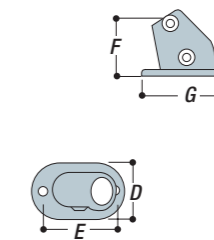

TYPE	Tube ref.	mm					Kg
	A	D	E	F	G	Ø	
363-7	7	76	114	85	146	14	0.98
363-8	8	89	124	95	164	14	1.31

Ø indicates the diameter of the fixing hole.

427

Three Socket Tee (30°-45°)

This component is used on a safety railing with slopes between 30° and 45° and fixes the top-rail to a vertical intermediate upright.

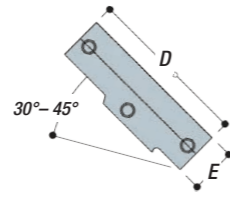
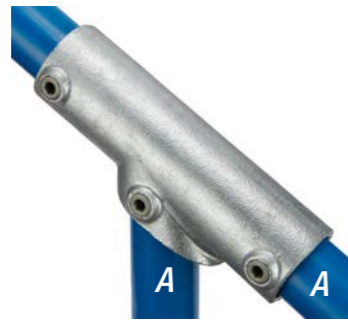

Kee Lite aluminium version available

TYPE	Tube ref.	mm			Kg
	A	D	E		
427-7	7	180	55		0.95
427-8	8	216	60		1.22

623

High Capacity Base Flange

A heavy duty base component for railings in areas that are prone to overcrowding, including stadiums, grandstands, theatres, cinemas, shopping malls and urban footpaths. It has been designed for railings that need to resist loadings of up to 3kN/m applied at the top-rail.

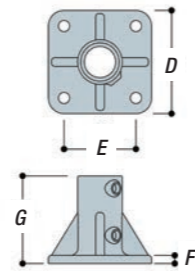

TYPE	Tube ref.	mm				Kg
	A	D	E	F	G	
623-8	8	153	103	12	140	4.09
623-9	9	165	115	13	140	3.72



Kee Klamp®

Access Safety Components

The Kee Klamp access range of tubular components are designed specifically to meet the requirements of the Equality Act 2010, the Building Regulations Part M and British Standard BS 8300. The components provide a cost-effective solution for handrail installations on both new and refurbishment projects.

The Kee Klamp access range of components have been designed to create a smooth handrail with size 7 tube (outside diameter 42.4mm). All components can be powder coated in a choice of RAL colours to meet the visibility and 'not cold to the touch' requirements of the building regulations.



ENGINEERING

The modular components are designed to suit BS EN 10255 (ISO 65) steel tubes. Components are made of galvanised cast iron to BS EN ISO 1461 for long-term maintenance; they are also available with polyester coating in any RAL colour.

Any Kee Klamp access railing system can be easily installed with a hex tool and tube cutters, and is therefore easily assembled without specialised workers or equipment, saving you both time and money.

Component by Function

COUPLINGS

514-7 Internal

ELBOWS

- 515-7** 90° Split
- 520-7** 90° Solid
- 554-7** Variable Angle
- 565-7** Wall Mounted End Return
- 567-7** End Post Handrail Return

HANDRAIL BRACKETS

- 518-7** Galvanised Inset
- 555-8** Top Fix Rail Assembly
- 561-7** Wall
- 565-7** Wall Mounted Return End
- 570-7** Galvanised Mounted
- 575-7** Upright Mounted Handrail Joiner
- 580-7** Wall Mounted Handrail Joiner

HANDRAIL SOCKETS

- 10-840C** Single Handrail Capped
- 10-848** Single Handrail
- A10-748** Add-on Single Handrail (32mm)
- A10-848** Add-on Split Single Handrail (38mm)
- 26-840** Twin Handrail
- 26-840C** Twin Handrail Capped

MISCELLANEOUS

- 84-848** Upright Top Cap
- 508-7** Gap Washer

Basic Assembly

How these components work together to give you the most durable, flexible, and compliant railing system for disability access.

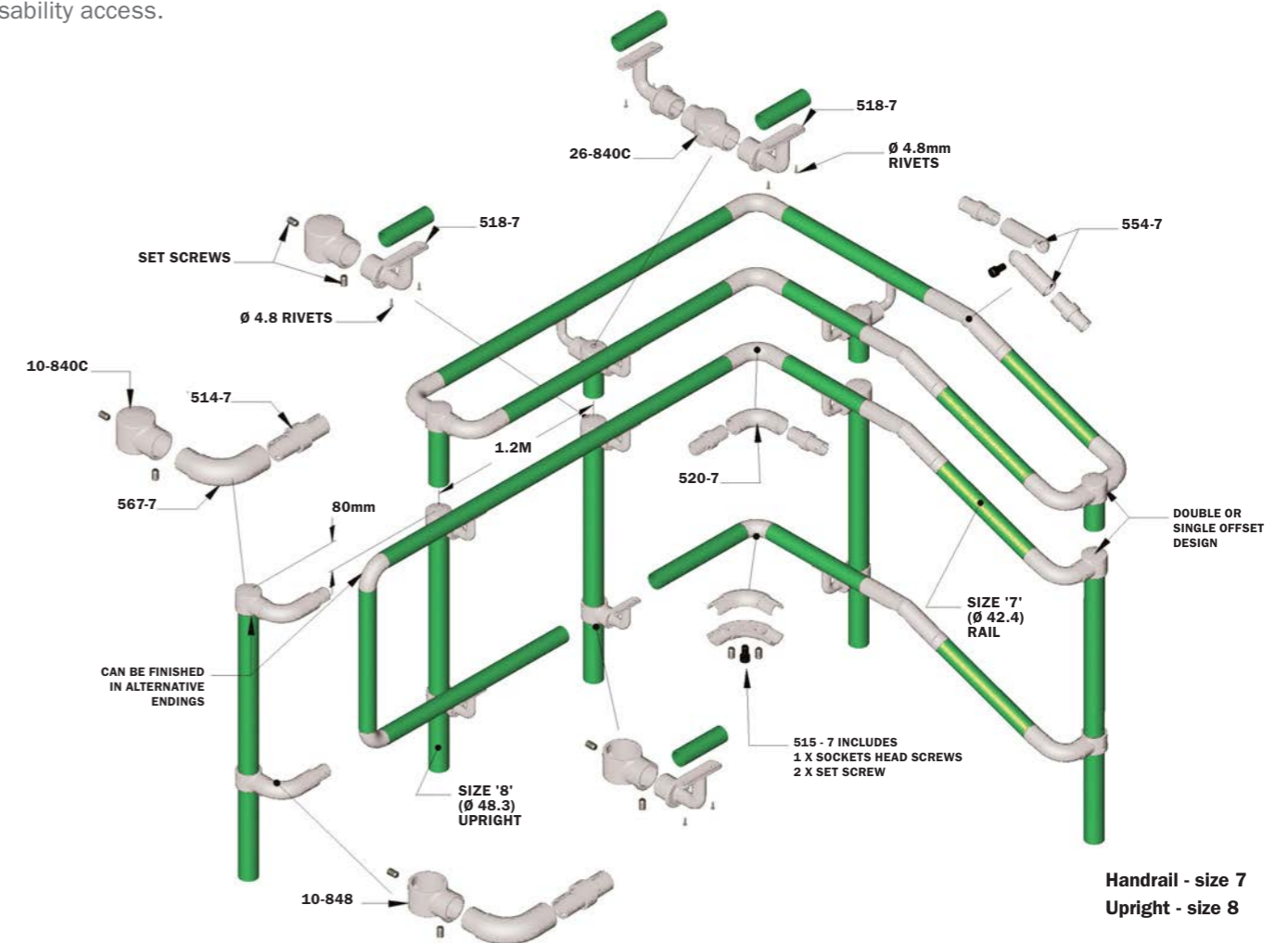

Handrail - size 7
Upright - size 8

10-840C

Single Handrail Socket Capped

Capped 90° socket tee designed for use at the termination of an upright where a handrail socket needs to be joined at the top of a post.

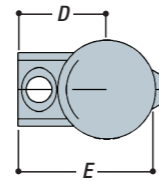
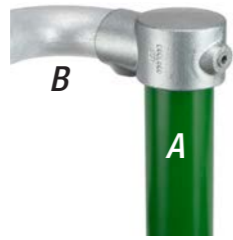

TYPE	Tube ref.		mm			Kg
	A	B	D	E	F	
10-840C	8	stub	55	85		0.41

10-848

Single Handrail Socket

A 'tee' component which has a handrail socket. Typically used for attaching mid-rail supports to an upright. For upgrading size 7 and size 8 systems see A10-748 and A10-848.

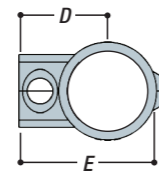
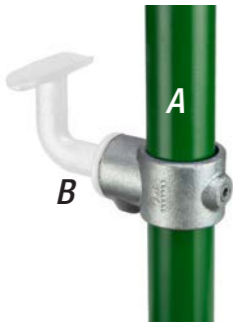

TYPE	Tube ref.		mm			Kg
	A	B	D	E	F	
10-848	8	stub	55	85		0.38

A10-748

Add-on Single Handrail Socket

The hinge and pin system of this socket tee enables existing structures to be easily modified without the need for dismantling. Hinges around existing size 7, or 32mm N.B. tube.

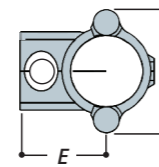
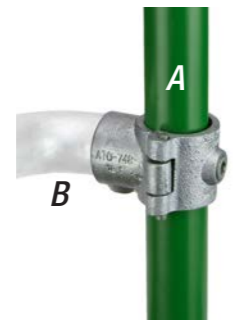

TYPE	Tube ref.		mm			Kg
	A	B	D	E	F	
A10-748	7	stub	76	53		0.53

A10-848

Add-on Single Handrail Socket

The hinge and pin system of this socket tee enables existing structures to be easily modified without the need for dismantling. Hinges around existing size 8, or 40mm N.B. tube.

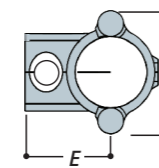
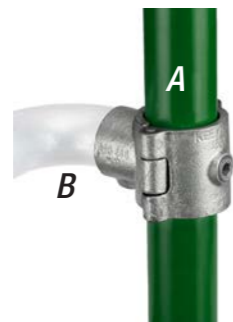

TYPE	Tube ref.		mm			Kg
	A	B	D	E	F	
A10-848	8	stub	82	55		0.62

26-840

Twin Handrail Socket

Component slips over upright to create two handrail sockets at 90°.

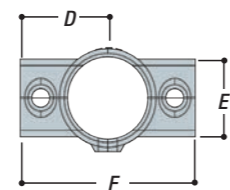
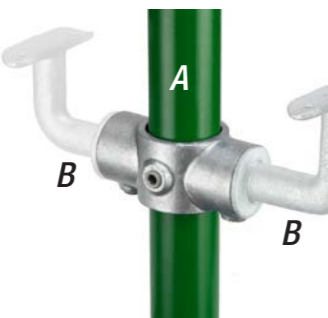

TYPE	Tube ref.		mm			Kg
	A	B	D	E	F	
26-840	8	stub	55	48	110	0.44

26-840C

Twin Handrail Socket Capped

Capped component for use at the termination of an upright to create two handrail sockets at 90° from the upright.

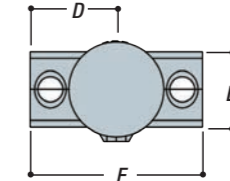
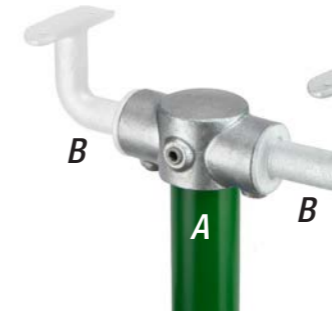

TYPE	Tube ref.		mm			Kg
	A	B	D	E	F	
26-840C	8	stub	55	48	110	0.50

84-848

Upright Top Cap

A metal drive-in plug which is difficult to remove when installed. The 84-848 is a cap for the open ends of size 8 uprights and covers the top of a 10-848 tee component.



Note: This component can only be used with EN 10255 Medium Tube.

508-7

Gap Washer (Optional)

A rubber gasket for use with size 7 components. Comes only in black.



514-7

Internal Coupling

Designed especially for DDA railing, this internal coupling can be powder coated (unlike the Type 18 component). The inset hex screw and precise coupling design allows handrail to be smooth and continuous. The internal coupling is a necessary component when installing Type 520-7, Type 554-7, Type 565-7 and Type 567-7.

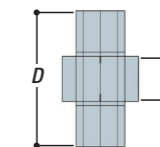

TYPE	Tube ref.		mm			Kg
	A	B	D	E	F	
514-7	7	stub	74	25		0.38

515-7

Split Elbow (90°)

This elbow consists of two separate pieces that are joined by a central screw. The component is positioned with the ends inside the adjoining handrails, and the outer grub screws tightened. This forces the halves apart, gripping the inside of the tube. The central screw is then tightened, locking the component in place.

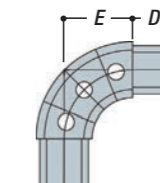

TYPE	Tube ref.		mm			Kg
	A	B	D	E	F	
515-7	7	stub	34	50		0.84

518-7

Handrail Bracket

An intermediate upright handrail support. This bracket is designed to be mounted into a socket component. The rail sits on the saddle and is secured by either Ø4.8mm x 15mm long aluminium multi-grip pop rivets or No. 10 x 20mm countersunk self-tapping screws.

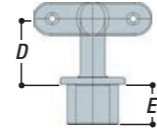
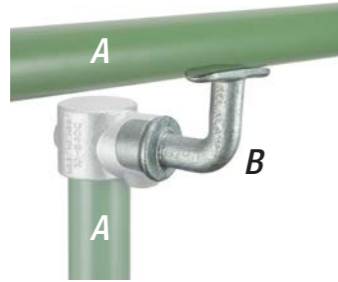

TYPE	Tube ref.		mm				Kg
	A	B	D	E	Ø		
518-7	7	socket	51	30	5	0.49	

Ø indicates the diameter of the fixing hole.

520-7

Solid Elbow (90°)

An alternative elbow to Type 515, two piece component. The elbow is designed to be joined to the handrails using two Type 514-7 internal couplings.

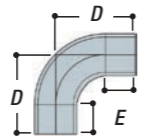

TYPE	Tube ref.	mm			Kg
		D	E	Ø	
520-7	7	80	30	0.40	

554-7

Variable Angle

A variable angle elbow for changes in elevation. This elbow allows for flexibility and a range of angles. The elbow is joined to rails using two Type 514-7 internal couplings.

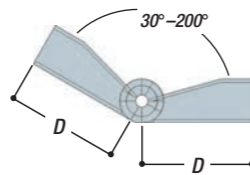

TYPE	Tube ref.	mm			Kg
		D	E	Ø	
554-7	7	108		0.33	

555-8

Top Fix Rail Bracket

An in-line, adjustable angle component for use where a handrail is mounted to the top of the upright. The saddle has a variable angle of 60° from the vertical.

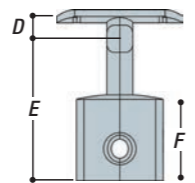
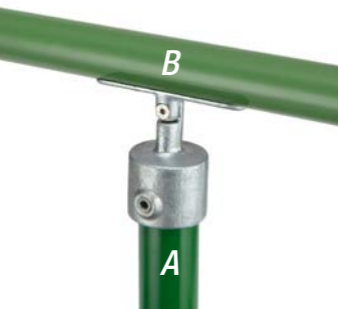

TYPE	Tube ref.		mm				Kg
	A	B	D	E	F	Ø	
555-8	8	7	13	89	48	5	0.50

Ø indicates the diameter of the fixing hole.

561-7

Wall Frange

A wall mounted handrail end flange. Four fixing holes are drilled and countersunk to suit 6mm diameter flat head wood screws. The handrail is joined to the flange with Type 514-7 Internal Coupling.

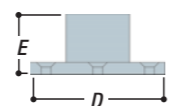

TYPE	Tube ref.	mm			Kg
		D	E	Ø	
561-7	7	90	40	7	0.35

Ø indicates the diameter of the fixing hole.

565-7

Wall Mounted End Return

A wall mounted handrail return bracket. The bracket is joined to handrail using Type 514-7 coupling. Three fixing holes are drilled and countersunk to suit No. 14 countersunk screws.

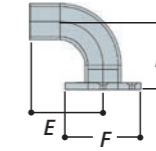

TYPE	Tube ref.		mm				Kg
	A	B	D	E	F	Ø	
565-7	7		82	86	90	7	0.67

Ø indicates the diameter of the fixing hole.

567-7

End Post Handrail Return

A handrail return bracket for use when mounting railing to an upright. This handrail is mounted to an upright using a handrail socket. Join the return handrail using Type 514-7 internal coupling.

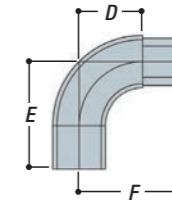
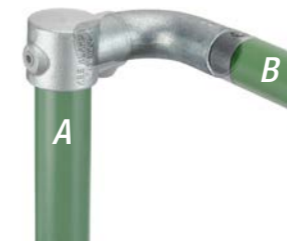

TYPE	Tube ref.		mm				Kg
	A	B	D	E	F	Ø	
567-7	7	stub	51	86	81	7	0.57

Ø indicates the diameter of the fixing hole.

570-7

Wall Mounted Handrail Bracket

A wall mounted version of the 518-7. The handrail tube sits on the 'saddle' and is secured using either No. 10 self-drilling screws or multi-grip pop rivets. This bracket provides holes for countersunk head fixing screws only. Three fixing holes are drilled and countersunk to suit 6mm diameter countersunk screws.

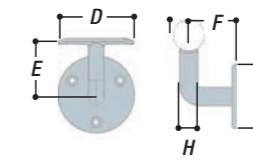

TYPE	Tube ref.		mm					Kg	
	A	B	D	E	F	G	H		Ø
570-7	7		88	63	82	90	25	7	0.67

Ø indicates the diameter of the fixing hole.

575-7

Upright Mounted Handrail Joiner

This bracket is designed to be mounted on a type 10-848, 26-840 or an A10-848 connecting two adjoining tubes without requiring pop rivets or self tapping screws. The inset setscrew and precise coupling design facilitates a smooth and continuous finished handrail.

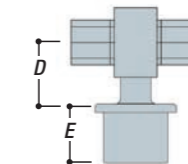
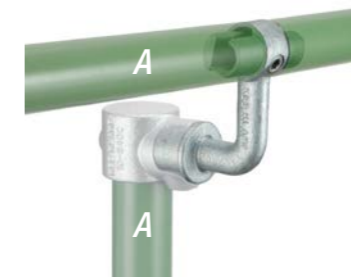

TYPE	Tube ref.		mm		Kg
	A	B	D	E	
575-7	7		51	30	0.79

580-7

Wall Mounted Handrail Joiner

A wall mounted version of the 575-7, comprises of three countersunk woodscrew fixing holes and connects two adjoining handrail tubes without requiring pop rivets or self tapping screws. The inset setscrew and precise coupling design facilitates a smooth and continuous finished handrail.

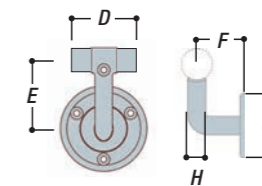

TYPE	Tube ref.		mm					Kg
	A	B	D	E	F	G	H	
580-7	7		75	84	82	90	25	0.99

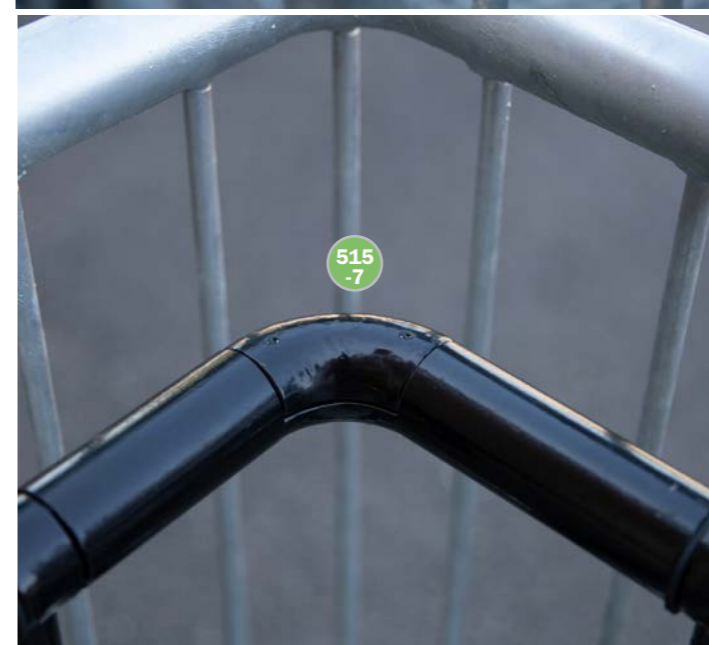
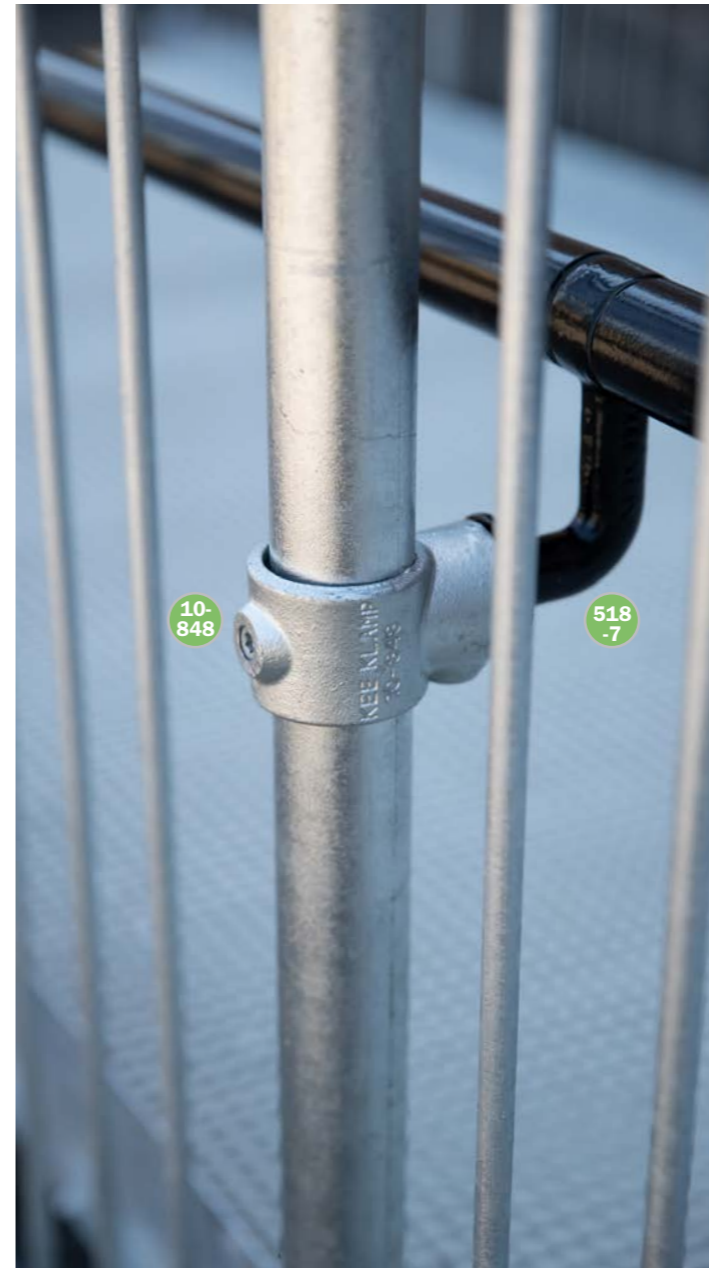

Aluminium Safety Components

Kee Lite components are made from a high grade Aluminium Silicon Magnesium Alloy. They are strong yet light, and extremely durable – even in harsh environments. They are only one-third the weight of iron components, with about 75% of comparable tensile strength. Kee Lite components are designed to suit BS EN755 tube.



Kee Lite components offer flexibility and can be used in a variety of applications, from contemporary to industrial: your imagination is the only limitation.

Because Kee Lite can be easily installed with a hex tool and tube cutters, there is no need for welding or specialist installation skills, saving you both time and money.

Kee Lite is securely locked into place using recessed set screws that provide a sleek and smooth look to your railing system. Kee Lite components are available for tube sizes 25, 32, 40 and 50 N.B.

Component by Function

COUPLINGS

L14 Straight

CROSSES

- L26** Two Socket
- L30** Adjustable 11°–30°
- L35** Three Socket
- L40** Four Socket
- L326** Level to Sloping Down or Up 30°–45°

CROSSOVERS

- L45** Crossover
- L46** Combination Socket Tee

ELBOWS

- L15** 90°
- L20** Side Outlet
- LB54** Adjustable
- L55** Obtuse Angle
- L55A** Variable 30°–60°
- L56** Acute Angle 30°–45°
- L56A** Acute Angle 11°–30°
- L320LH** Left Hand Level to Sloping Down Side Outlet 30°–45°
- L320RH** Right Hand Level to Sloping Down Side Outlet 30°–45°

FLANGES

- LC58** Swivel
- LM58** Double Swivel
- L61** Male Double Swivel
- L62** Male Corner Swivel
- L63** Angle Base 45°–60°
- L67** Angle
- L68** Wall
- L69** Railing Flange with Toeboard Adaptor
- L148** Heavy Duty Rectangular
- L150** Heavy Duty Four Hole
- L152** Four Hole Square
- L164** Offset Wall
- L262** Round Base

BRACKETS

- L70** Rail Support
- L160** Smooth Handrail Fitting
- 475** Aluminium Wall Bracket

PLUGS

- 77** Plastic
- L84** Aluminium

COMBINATION SWIVELS

- LC50** Single Combination
- LF50** Female Single
- LM50** Male Single
- LC51** Double Combination
- LM51** Double Male
- LC52** Corner Combination
- LM52** Male Corner

TEES

- L10** Single Socket
- L19** Adjustable Side Outlet
- L21** Side Outlet 90°
- L25** Three Socket
- L29** Single Socket 30°–60°
- L46** Combination Socket Tee and Crossover
- L114** Swivel
- L321LH** Left Hand Level to Sloping Down Side Outlet 30°–45°
- L321RH** Right Hand Level to Sloping Down Side Outlet 30°–45°
- L325** Level to Sloping Down 30°–45°
- L325A** Level to Sloping Up 30°–45°
- L427** Three Socket 11°–30°

TOEBOARD KITS

TBI Toeboard

MISCELLANEOUS

Gaskets Neoprene Flange Gasket

L10

Single Socket Tee

This component creates a 90° perpendicular joint between two tubes.

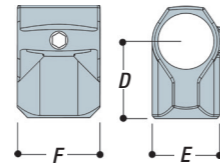
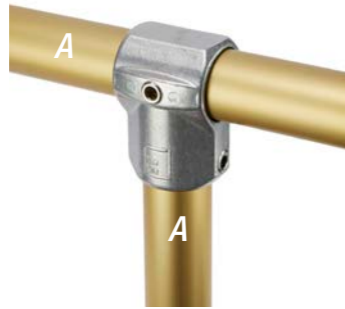

TYPE	Tube ref.	mm			Kg
	A	D	E	F	
L10-6	6	52	42	56	0.13
L10-7	7	65	53	64	0.20
L10-8	8	74	60	70	0.30
L10-9	9	90	74	82	0.48

L14

Straight Coupling

Designed to give an in-line joint between tubes of the same size. Frequently used to enable full tube lengths to be used in railing applications.

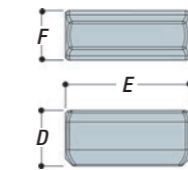

TYPE	Tube ref.	mm			Kg
	A	D	E	F	
L14-6	6	50	100	42	0.18
L14-7	7	59	130	53	0.24
L14-8	8	65	148	60	0.36

Note: It is not advisable to join the upper and lower rails of a railing within the same bay.

L15

Elbow (90°)

A 90° elbow joint, most frequently used as an end joint for the top-rail of safety railing on a level site.

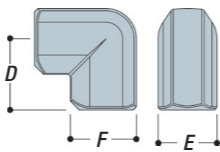

TYPE	Tube ref.	mm			Kg
	A	D	E	F	
L15-6	6	52	42	56	0.14
L15-7	7	65	53	59	0.28
L15-8	8	74	60	65	0.40
L15-9	9	90	74	78	0.66

L19

Adjustable Side Outlet Tee (60°–200°)

Used to form variable angle joints between 60° and 200°. Not designed to absorb bending loads at barrier intersection.

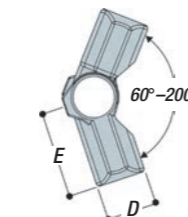
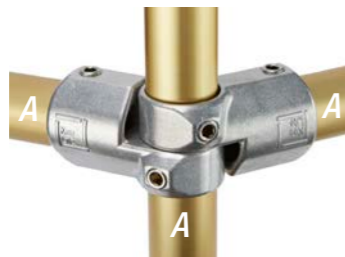

Note: Type L19 components are bagged in pairs and are weighed, priced, and sold as such. Weight below refers to pairs.

TYPE	Tube ref.	mm			Kg
	A	D	E	F	
L19-6	6	42	75	0.36	
L19-7	7	53	90	0.58	
L19-8	8	60	90	0.66	

L20

Side Outlet Elbow (90°)

A 90° corner joint most frequently used for the top-rail of safety railing. It can also be used for the corner joint of benches, work tables and other rectangular structures.

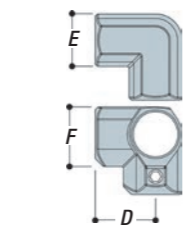
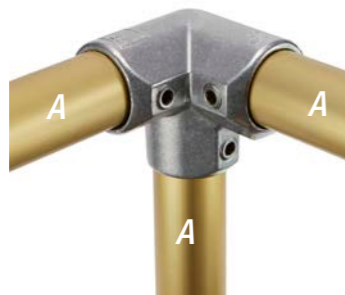

TYPE	Tube ref.	mm			Kg
	A	D	E	F	
L20-6	6	52	42	50	0.19
L20-7	7	65	53	59	0.35
L20-8	8	74	60	65	0.50

L21

Side Outlet Tee (90°)

Most frequently paired with type L20 to give a 90° corner joint for the middle rail of safety railing and other rectangular structures. The upright passes through the component.

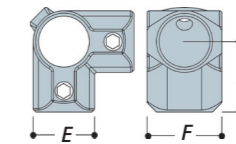
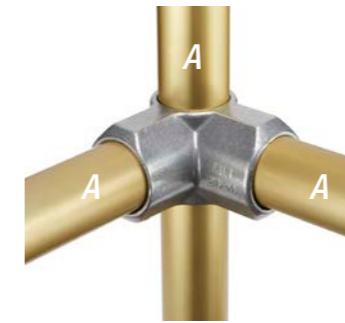

TYPE	Tube ref.	mm			Kg
	A	D	E	F	
L21-6	6	52	42	56	0.16
L21-7	7	65	53	64	0.30
L21-8	8	74	60	70	0.43

L25

Three Socket Tee

Commonly used as the 90° joint between the top-rail and an intermediate upright on safety railing. As there are two socket set screws in the sleeve, this component can be used where a join is required in the horizontal tube. The Type L10 component can be used as an alternative when a join in the tube is not required.

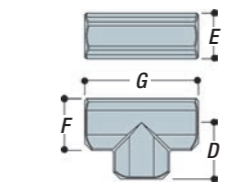
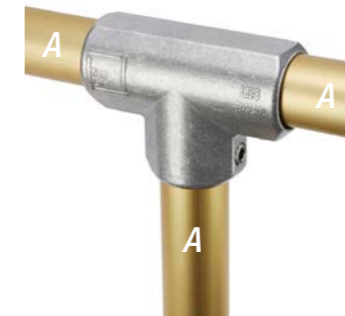

TYPE	Tube ref.	mm				Kg
	A	D	E	F	G	
L25-6	6	52	42	50	104	0.21
L25-7	7	65	53	59	130	0.35
L25-8	8	74	60	65	148	0.51
L25-9	9	90	74	78	180	0.93

L26

Two Socket Cross

Usually paired with Type L25 to give a 90° joint between the middle rail and an intermediate upright on safety railing. The upright passes through the component.

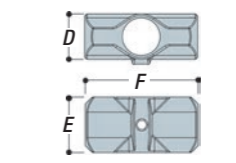
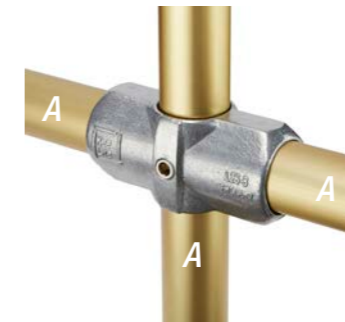

TYPE	Tube ref.	mm			Kg
	A	D	E	F	
L26-6	6	42	56	104	0.17
L26-7	7	53	64	130	0.28
L26-8	8	60	70	148	0.45
L26-9	9	74	82	180	0.66

L29

Single Socket Tee (30°–60°)

This adjustable component is most frequently used for struts and braces. It can be used at any selected angle between 30° and 60°. Suitable for connecting an angled staircase rail to a vertical upright.

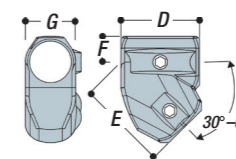
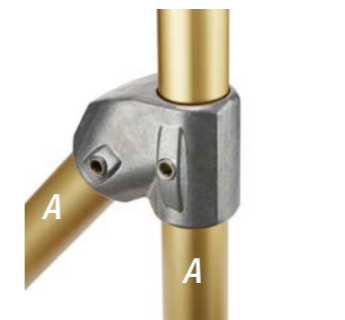

TYPE	Tube ref.	mm				Kg
	A	D	E	F	G	
L29-7	7	82	95	27	53	0.32
L29-8	8	93	108	30	59	0.41

L30

Adjustable Cross (30°–45°)

This adjustable component can be used for railing on staircases between the mid-rail and intermediate upright which is required to remain vertical. It can be used at any selected angle between 30° and 45°.

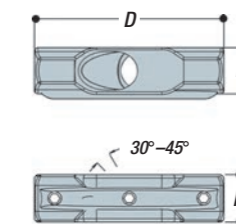
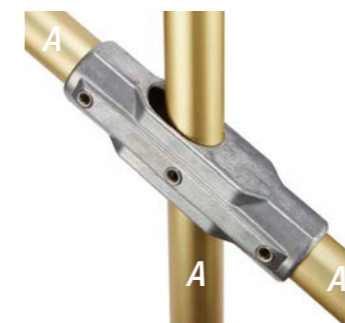

TYPE	Tube ref.	mm			Kg
	A	D	E	F	
L30-7	7	215	53	54	0.52
L30-8	8	245	59	60	0.83

L35

Three Socket Cross

Most frequently used to tie uprights with horizontal tube in three directions, all 90° to the upright. The upright passes through the component.

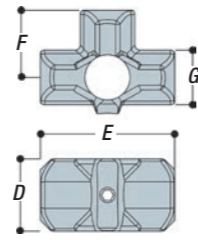
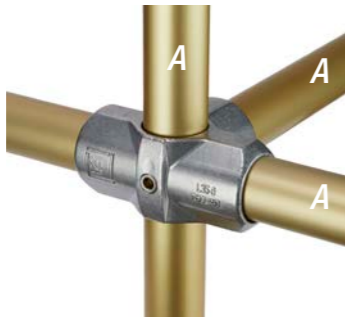

TYPE	Tube ref.		mm					Kg
	A	D	E	F	G			
L35-6	6	56	104	52	43	0.31		
L35-7	7	64	130	65	53	0.41		
L35-8	6	70	148	74	60	0.54		

L40

Four Socket Cross

Most frequently used in multiple upright structures to tie a centre upright with horizontal tubes in four directions. The upright passes through the component.

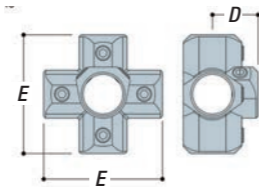
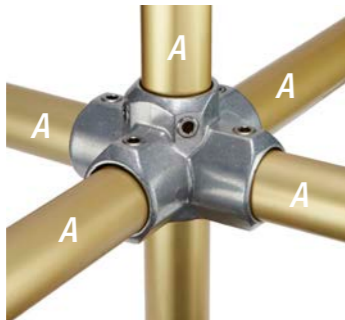

TYPE	Tube ref.		mm		Kg
	A	D	E		
L40-7	7	130	50	0.52	
L40-8	8	148	59	0.6	

L45

Crossover

Designed to give a 90° offset crossover joint. Frequently used on safety railing utilising a continuous horizontal rail, minimising tube cuts to reduce costs. Type L45 may also be used to allow intermediate levels on racks.

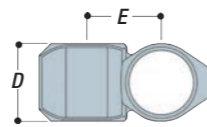
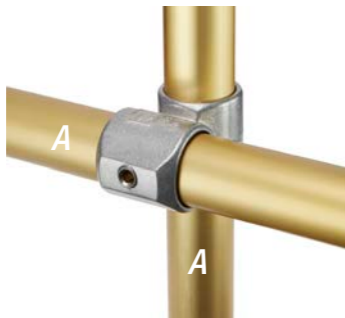

TYPE	Tube ref.		mm		Kg
	A	D	E		
L45-6	6	44	40	0.12	
L45-7	7	54	50	0.21	
L45-8	8	61	56	0.35	

L46

Combination Socket Tee and Crossover

Used on racking to join horizontal carrying rails to the upright, leaving the socket to take a horizontal tube outside the upright. On pallet racking, it is preferable to have the carrying rails inside the upright.

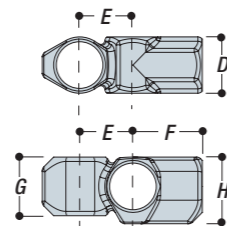
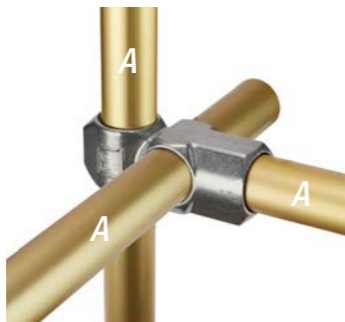

TYPE	Tube ref.		mm					Kg
	A	D	E	F	G	H		
L46-6	6	42	40	52	44	50	0.19	

LC50

Single Swivel Socket

A complete combination swivel component, variable through 170°

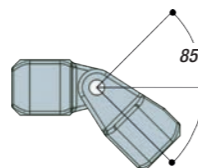
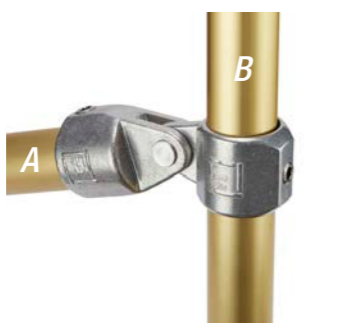

TYPE	Tube ref.		Kg
	A	B	
LC50-66	6	6	0.21
LC50-77	7	7	0.44
LC50-88	8	8	0.53

WARNING: Swivel components are not designed to resist bending loads. A structure should not be designed entirely of swivel components as they will not provide sufficient stability for the structure.

LF50

Female Single Swivel Socket Member

The female part of a swivel component combination.

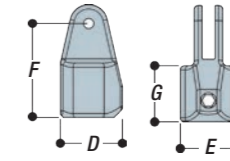

TYPE	Tube ref.		mm					Kg
	A	D	E	F	G			
LF50-6	6	50	42	75	53	0.17		
LF50-7	7	59	53	90	59	0.25		
LF50-8	8	65	60	90	67	0.29		

LM50

Male Single Swivel Socket Tee

The male portion of a swivel component combination. The component can also be used to attach flat panels to tubular structures.

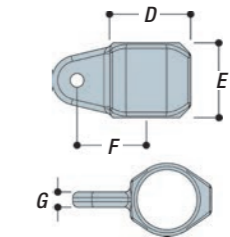

TYPE	Tube ref.		mm					Kg
	A	D	E	F	G	Ø		
LM50-6	6	50	44	47	11	10	0.12	
LM50-7	7	59	51	50	11	10	0.15	
LM50-8	8	65	60	55	11	10	0.20	

Ø indicates the diameter of the fixing hole.

LC51

Double Swivel Socket

Complete combination component. Reducing combinations of Type LC51 are available in sizes 6, 7 and 8.

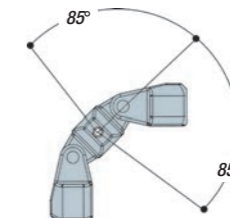
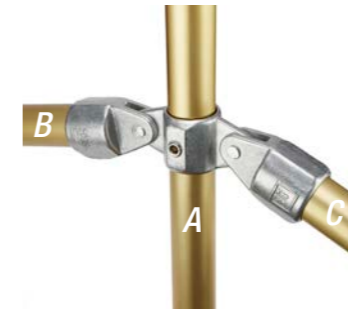

TYPE	Tube ref.			Kg
	A	B	C	
LC51-666	6	6	6	0.48
LC51-777	7	7	7	0.69
LC51-888	8	8	8	0.77

LM51

Male Double Swivel Socket Member

One half of a combination component. This component can also be used for attaching flat panels to tubular structures.

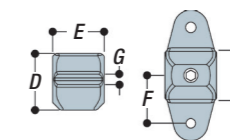

TYPE	Tube ref.		mm					Kg
	A	D	E	F	G	H	Ø	
LM51-6	6	50	44	47	11	42	10	0.16
LM51-7	7	59	51	50	11	53	10	0.20
LM51-8	8	65	60	55	11	60	10	0.27

Ø indicates the diameter of the fixing hole.

LC52

Corner Swivel Socket

Complete combination component. Reducing combinations of type LC52 are available in sizes 6, 7 and 8. See Type LM52 and Type LF50 for measurements.

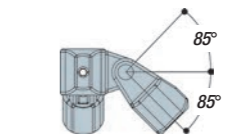
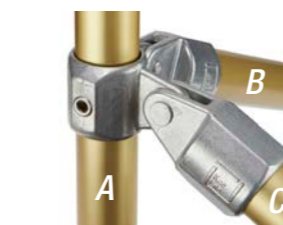

TYPE	Tube ref.			Kg
	A	B	C	
LC52-666	6	6	6	0.59
LC52-777	7	7	7	0.67
LC52-888	8	8	8	0.85

Note: Swivel components are not designed to resist bending loads. A structure should not be designed entirely of swivel components as they will not provide sufficient stability for the structure.

Kee Klamp steel version available

LM52

Male Corner Swivel Socket Member

One half of a combination component. This component can also be used for attaching flat panels to tubular structures.

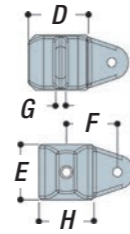

TYPE	Tube ref.	mm						Kg
		A	D	E	F	G	H	
LM52-6	6	50	44	47	11	42	10	0.16
LM52-7	7	59	51	50	11	53	10	0.23
LM52-8	8	65	60	55	11	60	10	0.27

∅ indicates the diameter of the fixing hole.

LB54

Adjustable Elbow (45°–200°)

A swivel component designed as an in-line variable angle connection, adjustable from 45° to 200°.

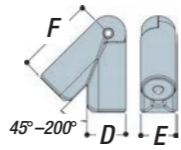

TYPE	Tube ref.	mm				Kg
		A	D	E	F	
LB54-66	6	50	42	100	0.35	
LB54-77	7	58	55	119	0.65	
LB54-88	8	65	60	131	0.73	

L55

Obtuse Angle Elbow

The Type L55 is an ideal component to use as an alternative to bending, or when a junction between a sloping tube and an end post (i.e. guardrail and staircases).

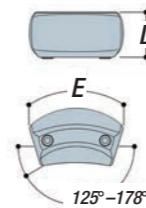

TYPE	Tube ref.	mm			Kg
		A	D	E	
L55-6	6	50	114	0.17	
L55-7	7	58	152	0.33	
L55-8	8	64	150	0.36	

L55A

Variable Elbow (11°–30°)

The Type L55A is an ideal component to use as an alternative to bending or when a junction between a sloping tube and an end post.

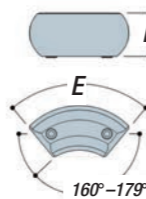

TYPE	Tube ref.	mm			Kg
		A	D	E	
L55A-6	7	59	165	0.29	
L55A-7	8	64	165	0.39	

L56

Acute Angle Elbow (30°–45°)

Type L56 is an ideal component to use as an alternative to bending, or when a junction between a sloping tube (30°–45°) and an end post (i.e. guardrail and staircases).

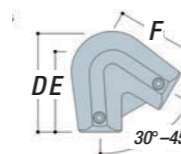
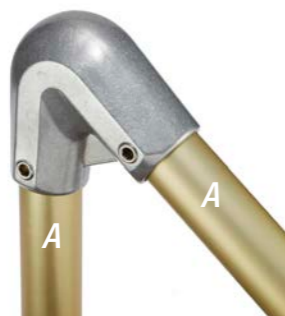

TYPE	Tube ref.	mm			Kg
		A	D	F	
L56-7	7	137	99	99	0.47
L56-8	8	120	112	120	0.62

L56A

Acute Angle Elbow (11°–30°)

Type L56A is an ideal component to use as an alternative to bending, or when a junction between a sloping tube (11°–30°) and an end post (i.e. guardrail on staircases) between.

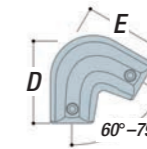

LC58

Swivel Flange

A swivel component for attachment of angled tube to a flat surface. See Type LM58 and Type LF50 for measurements.

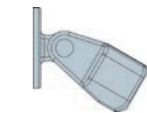

LM58

Double Swivel Socket

The male part of a swivel component for attaching angled tubing to flat surfaces.

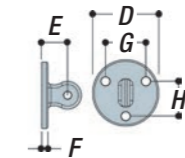

TYPE	mm					Rivet hole dia. (mm)	Fixing hole dia. (mm)	Kg
	D	E	F	G	H			
LM58	86	34	8	53	45	10	11	0.17

∅ indicates the diameter of the fixing hole.

L61

Flange

This flange, with holes provided for countersunk head fixing screws only, is used in structures where the fixing required is positional only. Frequently used as a wall fixing bracket.

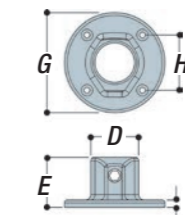
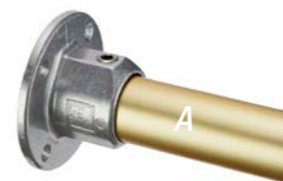

TYPE	Tube ref.	mm						Kg
		A	D	E	F	G	H	
L61-6	6	41	50	8	100	49	6	0.21
L61-7	7	53	55	8	110	61	6	0.29
L61-8	8	60	60	8	120	67	6	0.32

∅ indicates the diameter of the fixing hole.

WARNING: It is not recommended for use as a base flange to support guardrail or balustrades (see Type 62).

L62

Standard Railing Flange

Should always be used to fix guardrail. Holes are designed for both mechanical and chemical anchors. Two set screws in the vertical socket give greater stability to the upright. It is recommended that the fixing holes in the flange be in-line with the applied load.

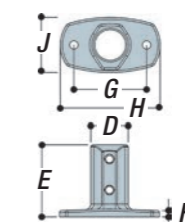

Note: The tube is able to pass through the base of the component.

TYPE	Tube ref.	mm							Kg
		A	D	E	F	G	H	J	
L62-6	6	42	90	9	89	128	75	14	0.35
L62-7	7	55	90	9	102	140	82	14	0.43
L62-8	8	62	90	9	115	160	84	14	0.47

∅ indicates the diameter of the fixing hole.

Kee Klamp steel version available

L63

Angle Base Flange (45°-60°)

Similar to a Type L62, but used to set up the upright at an angle between 45° to 60°. This component should only be subjected to light loads which cannot be positioned at 90° to the applied loads. For greater loads or other tube sizes, a Type L62 flange is used and the upright bent to the required angle.

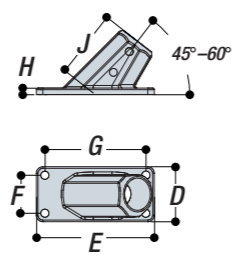
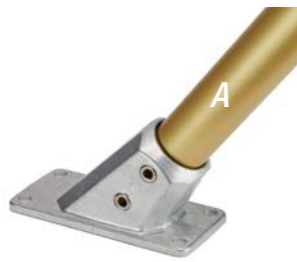

TYPE	Tube ref.	mm								Kg
		A	D	E	F	G	H	J	Ø	
L63-8	8	84	180	58	154	10	91	12	0.69	

L67

Angle Flange

Type L67 has been designed to allow the upright to pivot in the barrel, providing an angular displacement from 87° up to a maximum of 79°, measured from the vertical. Ideal to secure balustrade and guardrail systems on access ramps or other types of slopes.

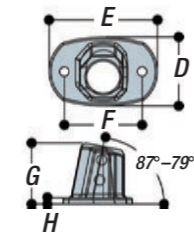
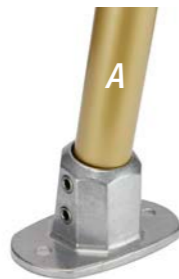

TYPE	Tube ref.	mm								Kg
		A	D	E	F	G	H	Ø		
L67-8	8	102	160	115	90	9	14	0.58		

L68

Wall Flange

Side palm flange for fixing guardrail and balustrades to walls, parapets, steps and ramps. The upright cannot drop through the socket. Note: If the upright is required to pass through the component by machining out the base stop, the bottom fixing hole becomes unusable.

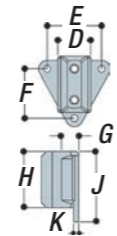

TYPE	Tube ref.	mm										Kg
		A	D	E	F	G	H	J	K	Ø		
L68-6	6	42	71	64	24	75	101	8	11	0.24		
L68-7	7	53	86	80	28	89	113	8	11	0.35		
L68-8	8	60	96	92	31	100	128	8	11	0.43		

L69

Railing Flange with Toeboard Adaptor

The railing flange has been designed for guardrail and balustrades and allows attachment of a toeboard to the base. The base plate can use a mechanical or chemical anchor; the side plates have slotted holes to allow for a degree of sideways movement for ease of installation.*

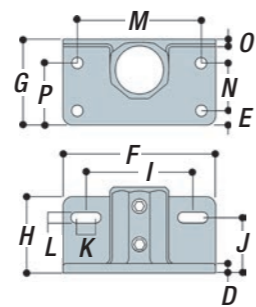

TYPE	Tube ref.	mm										Kg
		A	D	E	F	G	H	I	J	Ø		
L69-7	7	10	15	145	80	80	96	58			0.64	
		K	L	M	N	O	P	Ø				
L69-8	8	20	11	115	40	8	51	11			0.75	
		D	E	F	G	H	I	J				
		10	15	160	90	80	112	58				
		K	L	M	N	O	P	Ø				
		20	11	130	50	8	57	11				

Ø indicates the diameter of the fixing hole.

*A toeboard designed for use with Type L69 railing flange is available from Kee Safety. (See page 55.)

L70

Rail Support

This component, with holes provided for countersunk head screw fixings only, is designed to carry handrails along walls or to fix structures back to walls. The tube passes through the component and cannot be joined within the component. Type 70 is also used to attach toeboards to the base of guardrail uprights.

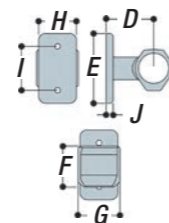

TYPE	Tube ref.	mm								Kg
		A	D	E	F	G	H	I	J	
L70-6	6	60	92	50	50	45	68	10	8	0.20
L70-7	7	68	105	59	60	54	81	10	8	0.34
L70-8	8	75	115	65	66	60	91	10	8	0.45

Ø indicates the diameter of the fixing hole.

WARNING: Type 70 components are not designed to be used as base flanges for full height guardrails or handrails.

L84

Metal Plug

A metal drive-in plug. For proper insertion, a rubber mallet should be used. The metal plug is difficult to remove once installed.

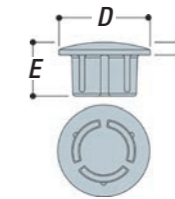

L114

Swivel Tee

An internal swivel component designed to accommodate varying angles on handrail, staircases, ramps or bracing. Used in conjunction with types L10, L15, L25 or L45, it eliminates the need for specialty drilled angle components.

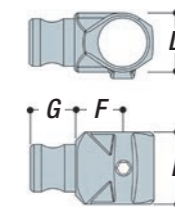

TYPE	Tube ref.	mm					Kg
		A	D	E	F	G	
L114-6	6	43	56	45	32	0.18	
L114-7	7	53	64	43	40	0.27	
L114-8	8	60	70	46	40	0.34	

Ø indicates the diameter of the fixing hole.

WARNING: This component is not recommended for use as a base flange to support guardrail or balustrades.

L148

Heavy Duty Rectangular Flange

This a structural base fixing is used to fix down guardrail and balustrades. Available with either two or four fixing holes. The two socket set screws give greater stability to the upright. It is recommended that fixing holes be in-line with the applied load.

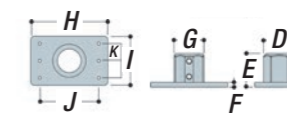

TYPE	Tube ref.	mm										Kg
		A	D	E	F	G	H	I	J	K	Ø	
L148-92	9	78	87	12	77	198	130	153	45	18	1.13	
L148-94	9	78	87	12	77	198	130	153	45	14	1.13	

Ø indicates the diameter of the fixing hole.

Note: The L148-92 has two holes; the L148-94 has four holes.

L150

Heavy Duty Four Hole Square Flange

A heavy duty, four point fixing flange. Ideal when a structural fixing is required.

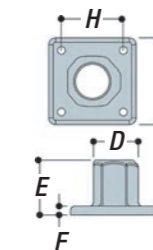

TYPE	Tube ref.	mm						Kg
		A	D	E	F	G	H	
L150-8	8	65	76	13	127	89	11	0.64

Ø indicates the diameter of the fixing hole.

L152

Four Hole Square Flange

A four point fixing flange.

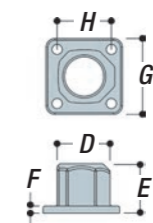

TYPE	Tube ref.	mm						Kg
		A	D	E	F	G	H	
L152-6	6	50	46	6	76	52	8	0.16
L152-7	7	59	55	8	85	61	11	0.27
L152-8	8	65	65	8	92	67	11	0.31

Ø indicates the diameter of the fixing hole.

L160

Smooth Handrail Fitting

Designed to provide attachment for a smooth handrail. The component swivels during installation, allowing the handrail to be placed at any angle. The component is supplied as a kit including fasteners.

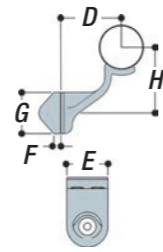
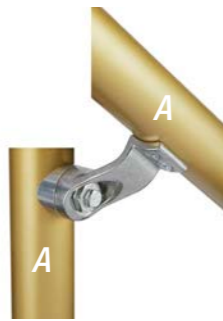

TYPE	Tube ref.		mm					Kg
	A	D	E	F	G	H		
L160-7	7	59	40	10	40	64	0.11	
L160-8	8	59	40	8	40	67	0.14	

L164

Offset Wall Flange

This component is designed for palm fixing of uprights to steel channels, walls, parapets, steps and ramps. The upright cannot drop through the socket.

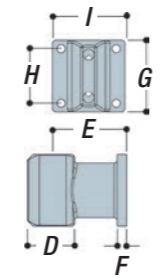

TYPE	Tube ref.		mm							Kg
	A	D	E	F	G	H	H	Ø		
L164-8	8	65	102	13	102	76	76	11	0.85	

Ø indicates the diameter of the fixing hole.

L262

Round Base Flange

Sleek round base flange. A single fixing hole is hidden to create a more aesthetic look. The two set screws in the vertical socket give greater upright stability.

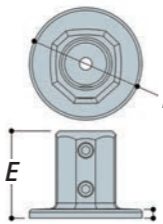
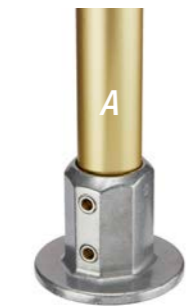

TYPE	Tube ref.		mm			Kg
	A	D	E	F	G	
L262-7	7	100	90	9	0.42	
L262-8	8	116	90	9	0.51	

L320LH

Left hand level to Sloping Down Side Outlet Elbow (30°-45°)

Left Hand Side Outlet Elbow component designed for the top-rail on guardrail on slopes and staircases between 30° and 45° at the junction where the handrail changes from level to sloping down the stairs.

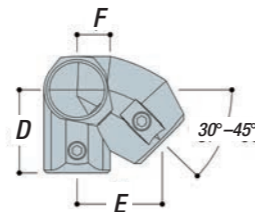
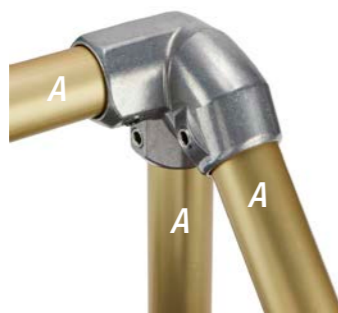

Note: handing perspective for Kee Lite is looking UP the staircase.

TYPE	Tube ref.		mm			Kg
	A	D	E	F	G	
L320LH-7	7	67	65	27	0.39	
L320LH-8	8	76	74	30	0.51	

L320RH

Right hand level to Sloping Down Side Outlet Elbow (30°-45°)

Right Hand Side Outlet Elbow component designed for the top-rail on guardrail on slopes and staircases between 30° and 45° at the junction where the handrail changes from level to sloping down the stairs.

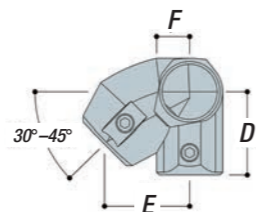

Note: handing perspective for Kee Lite is looking UP the staircase.

TYPE	Tube ref.		mm			Kg
	A	D	E	F	G	
L320RH-7	7	67	65	27	0.39	
L320RH-8	8	76	74	30	0.51	

L321LH

Left hand level to Sloping Down Side Outlet Tee (30°-45°)

Left Hand Side Outlet Tee component designed for the mid-rail on guardrail on slopes and staircases between 30° and 45° at the junction where the handrail changes from level to sloping down the stairs.

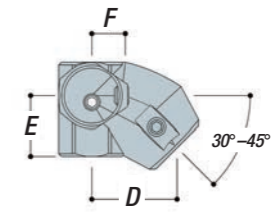
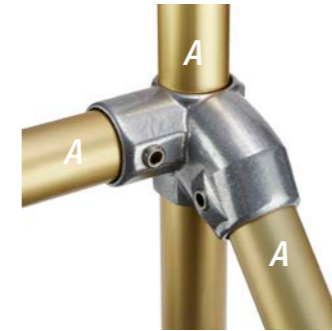

Note: handing perspective for Kee Lite is looking UP the staircase.

TYPE	Tube ref.		mm			Kg
	A	D	E	F	G	
L321LH-7	7	67	50	27	0.36	
L321LH-8	8	76	54	30	0.43	

L321RH

Right hand level to Sloping Down Side Outlet Tee (30°-45°)

Right Hand Side Outlet Tee component designed for the mid-rail on guardrail on slopes and staircases between 30° and 45° at the junction where the handrail changes from level to sloping down the stairs.

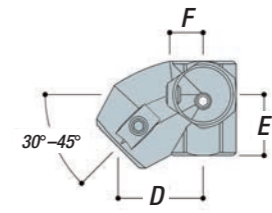
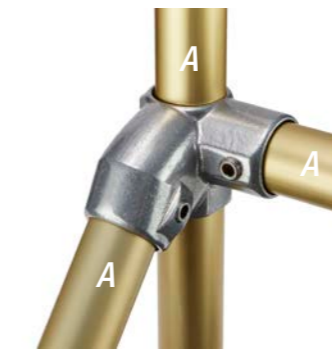

Note: handing perspective for Kee Lite is looking UP the staircase.

TYPE	Tube ref.		mm			Kg
	A	D	E	F	G	
L321RH-7	7	67	50	27	0.36	
L321RH-8	8	76	54	30	0.43	

L325

Level to Sloping Down Tee (30°-45°)

Tee component designed for the top-rail on guardrail on slopes and staircases between 30° and 45° at the junction where the handrail changes from level to sloping down the stairs.

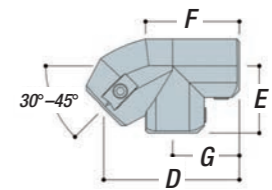
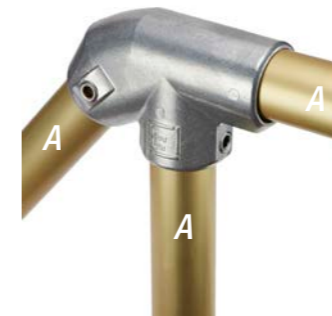

TYPE	Tube ref.		mm				Kg
	A	D	E	F	G		
L325-7	7	132	65	65	101	0.39	
L325-8	8	150	74	74	112	0.51	

L325A

Level to Sloping Up Tee (30°-45°)

Tee component designed for the top-rail on guardrail on slopes and staircases between 30° and 45° at the junction where the handrail changes from level to sloping up the stairs.

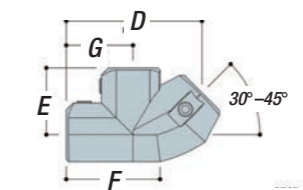
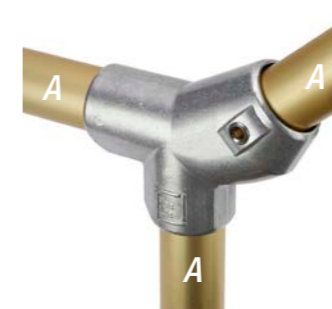

TYPE	Tube ref.		mm				Kg
	A	D	E	F	G		
L325A-7	7	132	65	65	101	0.39	
L325A-8	8	150	74	74	112	0.51	

L326

Level to Sloping Down or Up Cross (30°-45°)

Level to Sloping Down or Up Cross (30°-45°) Cross component designed for the mid-rail on guardrail on slopes and staircases between 30° and 45° at the junction where the handrail changes from either level to sloping down or level to sloping up the stairs.

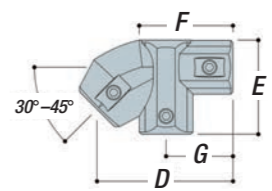
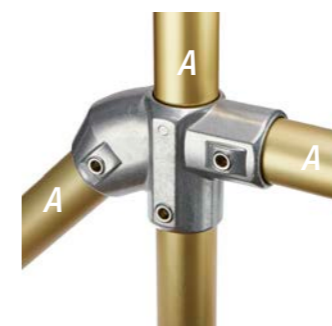

TYPE	Tube ref.		mm				Kg
	A	D	E	F	G		
L326-7	7	132	92	92	65	0.4	
L326-8	8	150	104	104	74	0.52	

L427

Three Socket Tee (30°-45°)

This component is used on a safety railing with slopes between 30° and 45° and fixes the top-rail to a vertical intermediate upright.

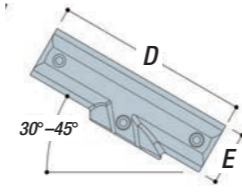
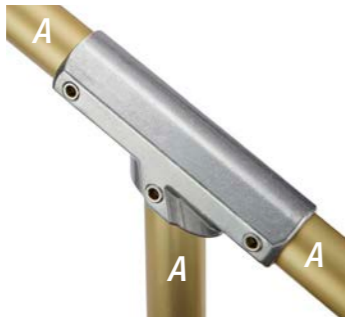

Keel Klamp steel version available

TYPE	Tube ref.	mm			Kg
	A	D	E		
L427-7	7	180	52	0.45	
L5427-8	8	216	59	0.64	

Gaskets

Neoprene Gaskets

Gaskets are available to prevent the corrosion associated with lime in concrete. The gaskets have more resistance than natural rubber to sunlight, ozone and oxidation. Neoprene is heat resistant and does not soften as natural rubber does under severe exposure. Gasket part numbers correspond to Keel Lite flange and base components as per table.



LG61-8	LG61-8	LG62-8	LG68-8	LG70-6	LG148-9	LG152-7
LG62-6	LG62-6	LG68-6	LG69-7	LG70-7	LG150-8	LG152-8
LG62-7	LG62-7	LG68-7	LG69-8	LG70-8	LG152-6	LG164-8

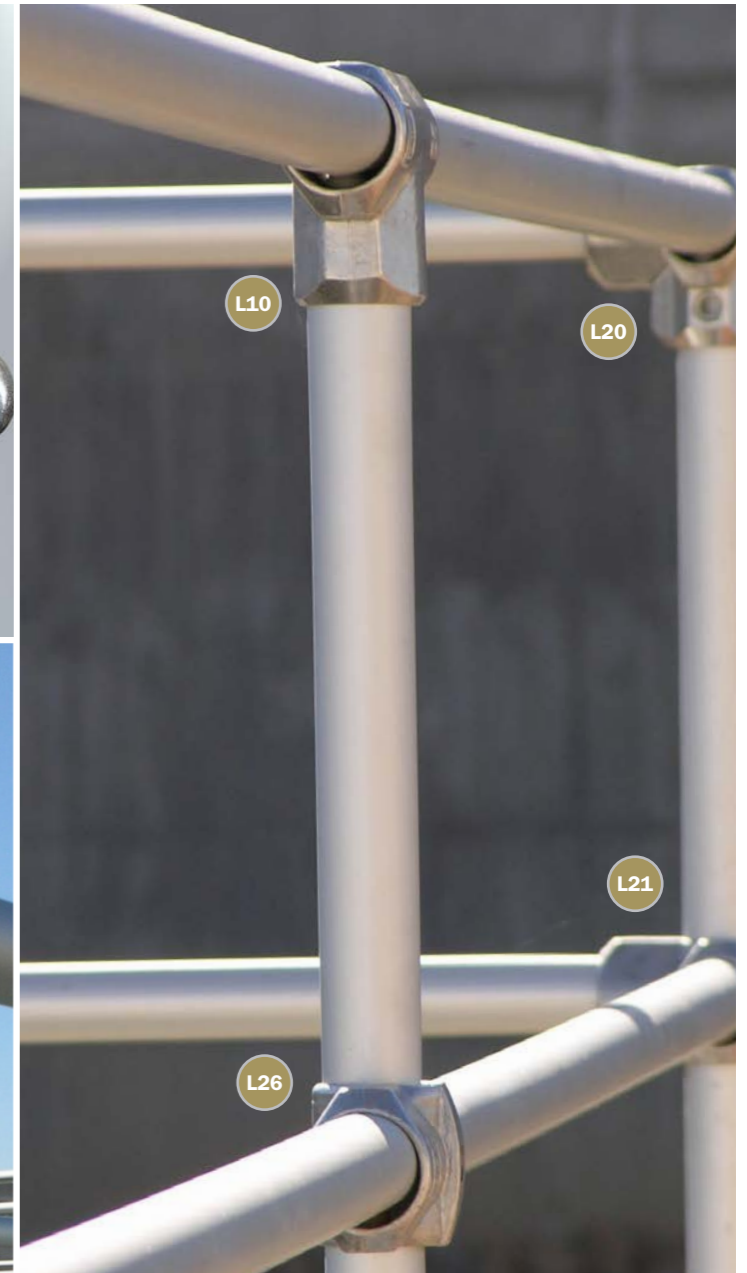

97

Set Screws

Socket set screws are supplied and inserted in all Kee Safety components as standard, the case hardened set screws that are fitted to Kee Klamp components are coated with Kee Koat. Kee Koat ensures at least four times the corrosion resistance of bright zinc plated alternatives. Kee Lite components are all supplied and fitted with grade 1.4301 stainless steel set screws.



TYPE	To suit tube sizes	Size	Finish
97-3	3	5/16" BSF	BZP
97-4	4	3/8" BSF	BZP
97-56	5 6	ISO 228 1/4"	KEE KOAT
97-789	7 8 9	ISO 228 3/8"	KEE KOAT
97-56050	5 6	ISO 228 1/4"	Grade 1.4301 Stainless Steel
97-78950	7 8 9	ISO 228 3/8"	Grade 1.4301 Stainless Steel

97ATD

Anti-theft Device

Aluminum drive rivets discourages the tampering of set screws whilst creating a nice finished appearance. Drive rivets are easy to install. The rivet pin is hit with a hammer driving it flush with the rivet head and expanding the rear of the rivet. No special tools are necessary. One size fits components 5-9.



98

Ratchet Set

Reversible ratchet for easier fastening of grub screws (1/2" Drive, 20cm long). Ratchet handle and hexagon bits are supplied separately. A/F refers to the dimensions across the flats.

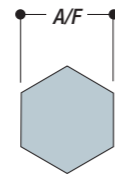

Note: Actual product may differ from that shown. Image is for illustration purposes only.

TYPE	To suit tube sizes	Sizes
98		Ratchet Handle (1/2" drive, 8" long)
98-56	5 6	Hexagon Bit (1/4" AF)
98-789	7 8 9	Hexagon Bit (5/16" AF)

99

Hex Key

Simple hex key. A/F refers to the dimension across the flats.

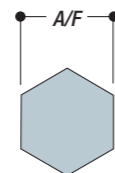

TYPE	To suit tube sizes	A/F
99-3	3	5/32"
99-4	4	3/16"
99-56	5 6	1/4"
99-789	7 8 9	5/16"

100

Plastic Set Screw Cap

Grey plastic set screw caps provide the perfect finishing touch to galvanised Kee Klamp components. Secure push-in-fit application.

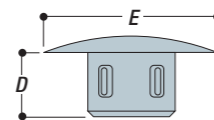

TYPE	To suit tube sizes	mm	
100-56	5 6	6 16	To fit 97-5 and 97-6 set screws
100-789	7 8 9	6 16	To fit 97-7, 97-8 and 97-9 set screws

I-FP

In-fill Panels

Panels in a variety of materials, sizes and finishes. The standard 50mm x 50mm weld mesh is available in either galvanised or powder coated finish. Maximum panel size is 240cm x 120cm. Smaller opening are also available (25mm x 25mm or 50mm x 50mm).



Kee Safety also offer made-to-order Vertical Bar Infill which is stronger than welded mesh and is normally fabricated from 12mm solid bar welded at 100mm centres. This complies with the 100mm sphere rule stated in BS 6180:1995, Clause 5.3. Perforated or solid infill is also available.

TB1

Toeboard Fixing Pack

Fixing pack consists of 2x M10 x 25mm hex head screws, 2x M10 form A flat washer, 2x M10 Form A spring washer, and 2x M10 full nut. All materials in A4-70 stainless steel.



TB2

Inline Toeboard Connector

Used to join two pieces of in-line toeboard as part of an installed system.

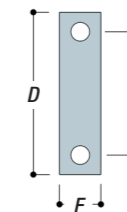

TYPE	mm			Kg
	D	E	F	
TB2	100	76	25	0.03

TB2C

90° Toeboard Connector

Used to join two pieces of toeboard that are 90° to each other to form a corner as part of an installed system.

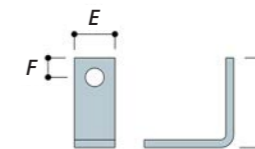

TYPE	mm			Kg
	D	E	F	
TB2C	55	25	12	0.03

TB3

Upright Toeboard Connector

Used to mount toeboard to a side fixed upright where the component is below the level of the parapet or similar.

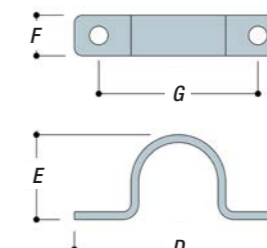

TYPE	mm				Kg
	D	E	F	G	
TB3	128	52	25	98	0.06

TB150

Toeboard

Used with both the Type 69 and Type L69 Railing Flange. The toeboard is 150mm high and is made of aluminium. A channel in the toeboard accepts the bolt head of the mounting hardware, allowing ease in placement. Toeboard is sold by the linear metre. It can be supplied adonised if required.

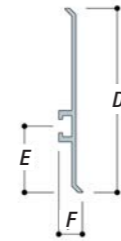
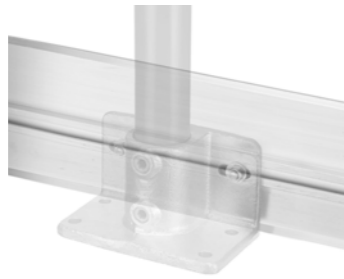

TYPE	mm			Kg
	D	E	F	
TB150	150	52	19	20.9kg/6.3m

Note: Mounting hardware is available separately.

05 52 00 Metal Railings

PART 1-1 GENERAL

- 1.1 SCOPE
- 1.2 RELATED WORK
- 1.3 RAILING STRUCTURAL REQUIREMENTS
- 1.4 SUBMITTALS
- 1.5 QUALITY ASSURANCE

PART 2-2 PRODUCTS

- 2.1 SUPPLIER
 - A. Manufacturer of handrail, guardrail or railing systems shall be the following except where otherwise noted on the Drawings:
 - Kee Safety Limited
 - Cradley Business Park
 - Overend Road, Cradley Heath, B64 7DW
 - Tel. +44 (0) 1384 632 188

2.2 SYSTEMS

- A. Handrails and Guardrails: Provide tube, Kee Klamp, Kee Lite or Kee Access fittings and accessories as indicated or required to match the design indicated in the Drawings.

2.3 METALS

- A. **Tube**
 - 1. Steel Tube: BS EN 10255 (ISO 65).
 - 2. Aluminium Tube: BS EN 755.
- B. **Fittings and Castings**
 - 1. Cast Iron Fittings or Castings to comply with BS EN 1562 and 1563.
 - 2. Hot Dip Galvanised finish to comply with BS EN ISO 1461.
 - 3. Aluminium Alloy Fittings or Castings conforming to A356-T6
 - 4. Brackets, Flanges and Anchors: Cast or formed metal of same material and finish as supported rails.

2.4 OTHER MATERIALS

2.5 FABRICATION-GENERAL

PART 3-3 EXECUTION

- 3.1 EXAMINATION AND PREPARATION
- 3.2 INSTALLATION
- 3.3 JOB CLOSE OUT

A brief three part specification for Kee Safety components is shown above for quick reference. The full specification is available for download on the Kee Safety website.

Kee Klamp Load Chart

Tube Size	6 3.2mm	7 3.2mm	7 4mm	8 3.2mm	8 4mm	8 5mm	9 3.65mm	9 4.5mm	9 5mm
Grade	EN 10255 Medium	EN 10255 Medium	EN 10255 Heavy	EN 10255 Medium	EN 39 Heavy	EN 10210 S355 JOH	EN 10255 Medium	EN 10255 Heavy	EN 10255 S355 JOH
Design Load Criteria	Upright Height 900mm								
360 N/m	1285mm (7.02KN)	2129mm (10.14KN)	2525mm (12.03KN)	2849mm (12.04KN)	2994mm (12.65KN)	3052mm (12.90KN)	3829mm (14.65KN)	3873mm (14.82KN)	4123mm (9.83KN)
740 N/m	625mm (7.02KN)	1036mm (10.15KN)	1228mm (12.03KN)	1396mm (12.04KN)	1977mm (17.17KN)	2350mm (20.41KN)	2441mm (19.20KN)	2672mm (21.02KN)	3286mm (16.10KN)
1500 N/m	308mm (7.01KN)	511mm (10.14KN)	606mm (12.03KN)	683mm (12.03KN)	975mm (17.17KN)	1682mm (29.62KN)	1204mm (19.20KN)	1318mm (21.02KN)	2525mm (25.07KN)
3000 N/m	152mm (5.35KN)	255mm (8.98KN)	303mm (10.67KN)	341mm (12.01KN)	487mm (17.15KN)	885mm (31.17KN)	600mm (21.13KN)	722mm (25.43KN)	1442mm (28.64KN)
Design Load Criteria	Upright Height 1000mm								
360 N/m	1150mm (6.98KN)	1909mm (10.11KN)	2263mm (11.98KN)	2556mm (12.00KN)	2849mm (13.38KN)	2930mm (13.76KN)	3718mm (15.81KN)	3781mm (16.08KN)	4023mm (10.53KN)
740 N/m	559mm (6.97KN)	928mm (10.10KN)	1101mm (11.98KN)	1243mm (12.00KN)	1775mm (17.13KN)	2168mm (20.93KN)	2191mm (19.15KN)	2398mm (20.96KN)	3143mm (16.91KN)
1500 N/m	276mm (6.98KN)	458mm (10.10KN)	543mm (11.98KN)	613mm (11.99KN)	875mm (17.12KN)	1432mm (28.02KN)	1081mm (19.15KN)	1183mm (20.96KN)	2313mm (25.23KN)
3000 N/m	136mm (6.88KN)	229mm (10.10KN)	271mm (11.96KN)	306mm (11.97KN)	437mm (17.10KN)	760mm (29.74KN)	540mm (21.13KN)	644mm (25.20KN)	1295mm (28.25KN)
Design Load Criteria	Upright Height 1100mm								
360 N/m	1040mm (6.94KN)	1728mm (10.06KN)	2048mm (11.93KN)	2315mm (11.96KN)	2668mm (13.78KN)	2778mm (14.35KN)	3580mm (16.74KN)	3665mm (17.14KN)	3906mm (11.14KN)
740 N/m	506mm (6.94KN)	840mm (10.06KN)	996mm (11.92KN)	1126mm (11.96KN)	1608mm (17.07KN)	1946mm (20.66KN)	1986mm (19.09KN)	2173mm (20.89KN)	2963mm (17.37KN)
1500 N/m	249mm (6.92KN)	414mm (10.05KN)	491mm (11.91KN)	555mm (11.94KN)	793mm (17.07KN)	1171mm (25.20KN)	980mm (19.10KN)	1072mm (20.89KN)	2016mm (23.96KN)
3000 N/m	123mm (6.93KN)	207mm (10.05KN)	245mm (11.89KN)	277mm (11.92KN)	396mm (17.05KN)	619mm (26.64KN)	490mm (19.10KN)	536mm (20.89KN)	1008mm (23.96KN)

Industrial Use-Non Emergency:

360 Newtons per metre run (N/m)

Commercial Use:

740 Newtons per metre run (N/m)

Retail/Public Access:

1500 Newtons per metre run (N/m)

Stadium:

3000 Newtons per metre run (N/m)

The current regulations give various design requirements to be fulfilled of which the Design Load is the most important.

Base upon rail diameter being the same as the upright but using BS EN 10255 medium wall tubing. Design Loads are as stated in BS 8118, BS 6180, BS 6399 and BS 7818. The above bay sizes are based upon using the Kee Klamp Type 62 base fitting fixed perpendicular to the line of the handrails. The figures shown in brackets are the required anchor pull out loads for the bay size indicated after all reduction factors have been applied.

Notes: The table is based on the maximum permissible bending moment of the tube.

- All rails are the same tube size as uprights but in BS EN 10255 medium grade tube
- Where tube is to be used to form ground sockets: a.) Tube size 6 fits inside tube size 7 medium grade only, b.) Tube size 8 fits inside tube size 9 all grades
- Based upon rail diameter being the same size and grades as the upright. Design Loads are as stated in BS 8118, BS 5950, BS 6180, BS 6399 and BS 7818
- To achieve bigger bay sizes than those stated please contact Kee Safety Ltd for further details

Kee Lite Load Chart

Tube Size	6 3.38mm	7 3.56mm	8 4.05mm	9 4.06mm
Grade	6082 T6	6082 T6	6082 T6	6082 T6
Design Load Criteria	Upright Height 900mm			
360 N/m	720mm	1388mm	1879mm	2490mm
740 N/m	N/A	N/A	1220mm	1940mm
Design Load Criteria	Upright Height 1000mm			
360 N/m	540mm	1117mm	1664mm	2370mm
740 N/m	N/A	N/A	950mm	1690mm
Design Load Criteria	Upright Height 1100mm			
360 N/m	400mm	871mm	1398mm	2205mm
740 N/m	N/A	N/A	730mm	1400mm

Kee Lite components are made from high grade Aluminium Silicon Magnesium Alloy.

Recommended set screw torque is 39Nm

- Minimum slip load capacity on aluminium tube: 7.56kN (safety factor = 2 with tube having a mini-

mum UTS of 275 N/mm²)

- Large grub screws are designed to resist thread stripping
- The core range of KEE LITE fittings has undergone independent testing by TÜV

Straight and Level Guard Rail

Using Types 10, 15, 20, 21, 25 and 26 or L10, L15, L20, L21, L25 and L26

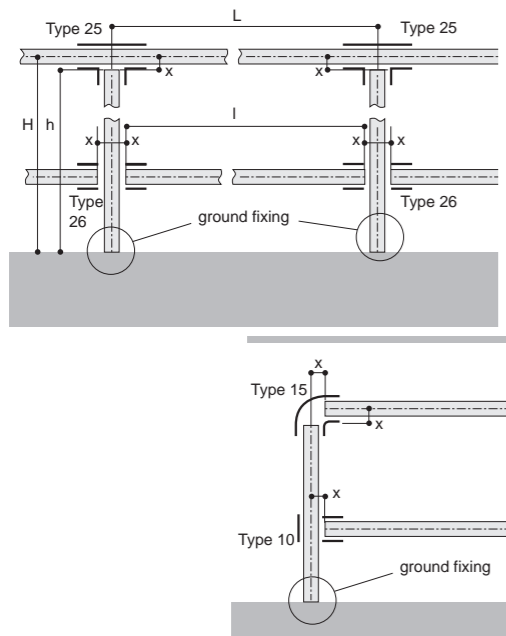

Where:
L = distance between centres of uprights
I = length of horizontal tube
H = distance from ground to centre line of top-rail
h = length of upright tube

Table 1
Dimension 'x' for fittings above, including Types 35, 40 and L35*

Fitting Size	x (mm)
3	-12
4	-13
5	-14
6	-17
7	-22
8	-25
9	-30

Table 1 gives details of dimension 'x' in the formula: $I = L - 2x$
 To calculate rail lengths and uprights use the formula: $h = H - x \pm$ (ground fixing)*

Note: When reducing fittings are being used care must be taken to use the correct 'x' dimension. (i.e., Type 10-87, vertical tube size 8, horizontal tube size 7. To find the correct length of the horizontal tube, the length 'x' is that for the size 8 vertical tube.) When using Types 35 and 40 the above 'x' dimension should be used. Although guardrailing is normally constructed in size 6, 7 and 8 tube, Table 1 shows the cutting length for all Kee Klamp tube sizes, and can therefore be applied to many other rectangular structures.

*When using Kee Lite bases, L61, L62, L69, L140, L150 and L152, "ground fixing" dimension will be zero.

Guardrailing up Slopes 0°-11°

Using Types 86, 87, 88 and 89

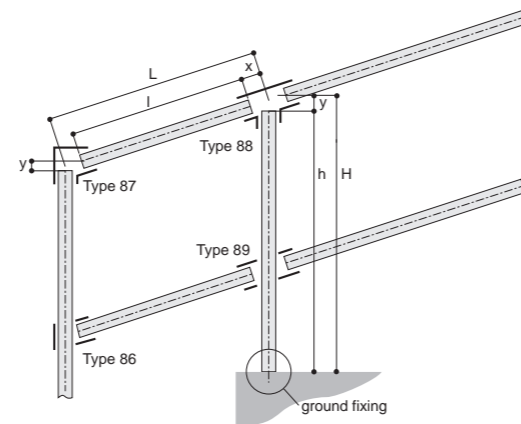

Where the upright remains vertical, i.e. ramps and stairways, (i) dimension 'x' to be subtracted from the upright centre dimension measured on the slope to give rail length. ($I = L - 2x$); (ii) dimension 'y' to be added to the centre dimension to give the length of the upright ($H = h + y +$ ground fixing).

Table 2
Rails

Angle of Slope	Size 8 Fittings 'x' (mm)
0° to 4°	-25
5° to 9°	-28
10° to 11°	-30

Table 2 gives details of dimensions required for calculating the rail lengths, where angles are between 0° and 11°.

Table 3
Uprights

Angle of Slope	Size 8 Fittings 'y' (mm)
0° to 4°	-25
5° to 9°	-28
10° to 11°	-30

Table 3 gives details of dimensions required for calculating the upright lengths, where angles are between 0° and 11°.

Guardrail Up Slopes 11° to 30°

Using Types 55A, 56A, 327, 328 and 329 size 7 and 8

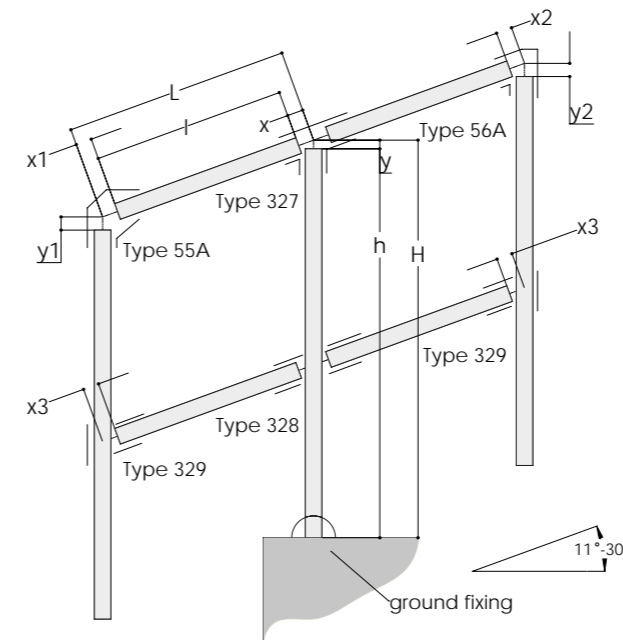

Where the upright remains vertical, i.e. stairways (i) dimension x, x1, x2, x3 to be subtracted from the upright centres; dimension (L) to give the rail length; (ii) dimension y, y1 and y2 for determining the upright length.

Table 1
Rails

Angle Of Slope	Fitting Size							
	7				8			
	x	x1	x2	x3	x	x1	x2	x3
11°	-26	-25	-35	-52	-29	-16	-35	-51
15°	-28	-21	-46	-53	-31	-27	-47	-52
20°	-30	-16	-48	-55	-34	-21	-49	-54
25°	-33	-15	-52	-59	-38	-22	-53	-57
30°	-37	-8	-57	-64	-42	-15	-59	-62

Table 1 gives details of dimensions required for calculating the rail lengths, where angle are between 11° & 30°.

Table 2
Uprights

Angle Of Slope	Fitting Size					
	7			8		
	y	y1	y2	y	y1	y2
11°	+7	-10	-28	+6	-7	-33
15°	+7	-11	-25	+6	-8	-30
20°	+7	-13	-34	+6	-10	-38
25°	+7	-15	-43	+6	-10	-48
30°	+7	-18	-53	+6	-14	-59

Table 2 Gives details of dimensions required for calculating the upright lengths.

Guardrail up Slopes 30° to 45°

Using Types 29, 30, 55, 56 and 427 in sizes 7 and 8

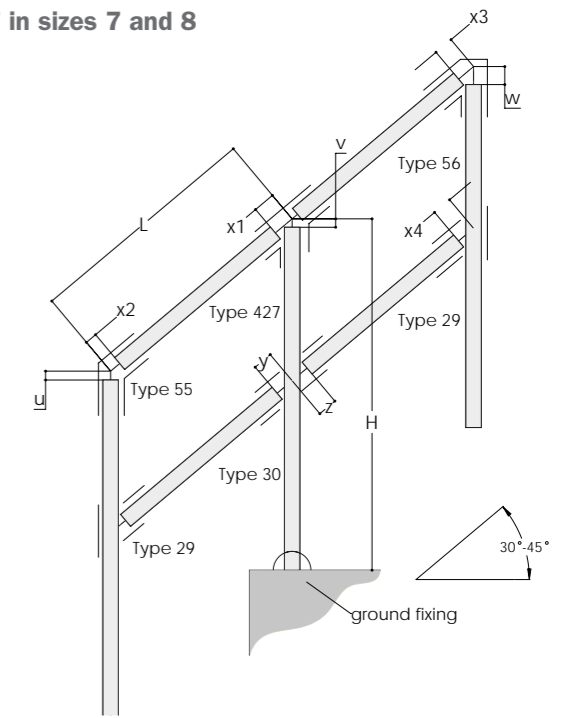

Where the upright remains vertical, i.e. stairways (i) dimension x, x1, x3, y & z to be subtracted from the upright centres; dimension (L) to give the rail length; (ii) dimension u, v and w for determining the upright length.

Table 3
Rails

Angle Of Slope	Fitting Size											
	7						8					
	x1	x2	x3	x4	y	z	x1	x2	x3	x4	y	z
30°	-39	-20	-55	-37	-49	-55	-45	-22	-49	-43	-60	-74
35°	-44	-16	-61	-40	-50	-54	-50	-18	-55	-47	-60	-74
40°	-47	-20	-71	-45	-51	-53	-55	-21	-66	-52	-61	-74
45°	-50	-26	-85	-51	-91	-53	-55	-26	-81	-59	-68	-66

Table 3 gives details of dimensions required for calculating the rail lengths, where angle are between 30° & 45°

Table 4
Uprights

Angle Of Slope	Fitting Size					
	7			8		
	u	v	w	u	v	w
30°	-17	+5	-48	-25	+6	-49
35°	-16	+5	-59	-21	+6	-59
40°	-8	+3	-69	-14	+6	-69
45°	+2	-1	-80	-2	-4	-81

Table 4 Gives details of dimensions required for calculating the upright lengths.

Guardrail up slopes 30° to 45°

Using 325, 325A, 326, size 7 and 8

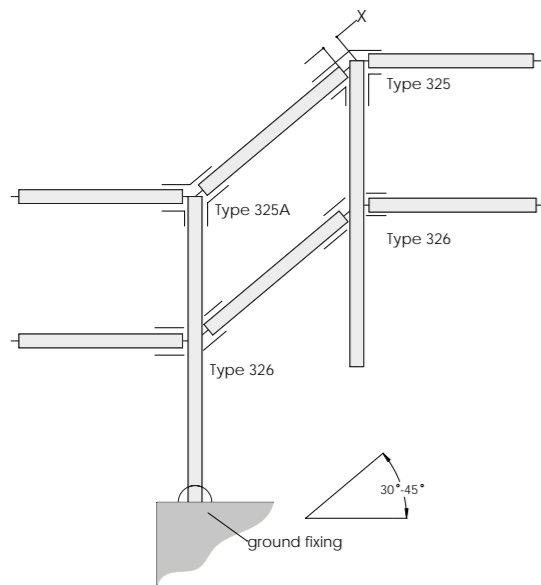

Table 5

Rails

Angle Of Slope	Fitting Size	
	7	8
	X	X
30°	-47	-57
35°	-52	-62
40°	-59	-69
45°	-68	-79

Table 5 gives details of dimensions required for calculating the rail lengths, where angle are between 30° & 45°

Slope Fittings

The latest addition to the Kee Klamp portfolio is an extension to the current range of slope fittings designed to enhance the building of guardrail along staircases and ramps particularly when the slope is greater than 30°. The range introduces single fittings to cater for situations where currently a combination of fittings is required. Not only does this improve the aesthetics of the finished guardrail but it also allows for a quicker and easier install. The range of slope fittings is available in Size 7 (outer diameter 42.4mm) and Size 8 (outer diameter 48.3mm) designed for use with steel tubing to BS EN 10255.

Kee Klamp fittings are iron castings manufactured to the requirements of BS EN 1562 & BS EN 1563. They are supplied hot dip galvanised to BS EN ISO 1461.

A Kee Klamp fitting can support an axial load of 900Kg per set screw tightened to a torque of 4Kgm (39 Nm). In common with all Kee Klamp products, the threaded recesses of each fitting are covered with Threskoat protective coating to provide enhanced corrosion resistance and all grub screws are manufactured in case hardened steel coated with Kee Coat for corrosion protection.

Guardrail up slopes 30° to 45°

Using 320RH, 320LH, 321RH and 321LH size 7 and 8

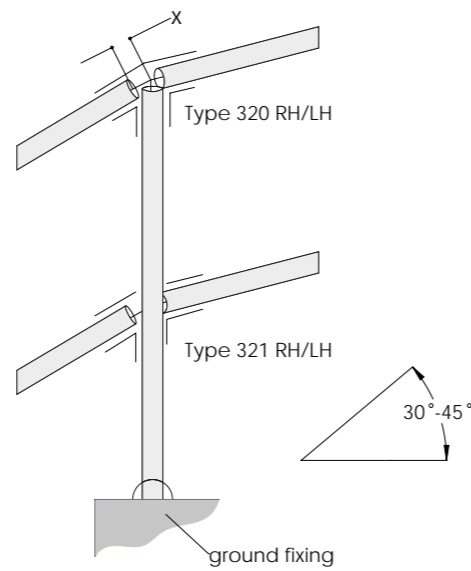

Table 6

Rails

Angle Of Slope	Fitting Size	
	7	8
	X	X
30°	-55	-62
35°	-60	-68
40°	-67	-76
45°	-77	-86

Table 6 gives details of dimensions required for calculating the rail lengths, where angle are between 30° & 45°

Features and Benefits

- Kee Klamp is the best known brand of slip-on tube fittings available for over 80 years
- Manufactured to stringent quality standards to ensure consistent performance
- Extended range of slope fittings gives greater design flexibility
- Adjustability in the fittings allows greater on-site tolerances to be met
- Using single fittings rather than pairs speed up installation times

Guardrailing up Slopes 11°–30°

Using Adjustable Fittings, Types 327 and 328

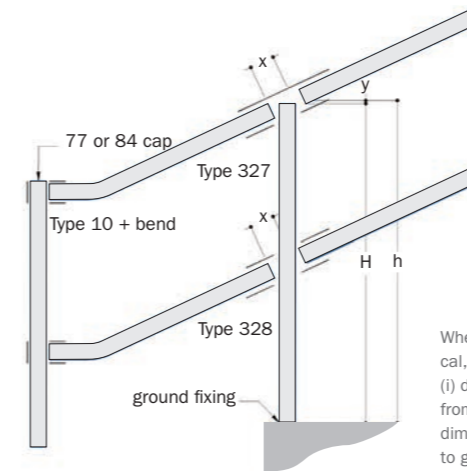

Where the upright remains vertical, i.e. ramps and stairways, (i) dimension 'x' to be subtracted from the upright centres dimension measured on the slope to give rail length. ($L = L - 2x$); (ii) dimension 'y' to be added to the centre dimension to give the length of the upright ($h = H + Y + \text{ground fixing}$).

Table 4

Rails

Angle of Slope	Size 7 Fittings: 'x' (mm)	Size 8 Fittings: 'x' (mm)
11°	-28	-30
15°	-32	-35
20°	-32	-38
25°	-35	-41
30°	-41	-44

Table 4 gives details of dimensions required for calculating the rail lengths, where angles are between 11° and 30°.

Table 5

Angle of Slope	Size 7 Fittings: 'y' (mm)	Size 8 Fittings: 'y' (mm)
11°	+16	+19
15°	+16	+19
20°	+13	+16
25°	+13	+16
30°	+13	+13

Table 5 gives details of dimensions required for calculating the upright lengths, where angles are between 11° and 30°.

Guardrailing up Slopes 30°–45°

Using Adjustable Fittings, Types 29, 30, 55 and 56 or Types L29 and L30 size 6, 7 and 8

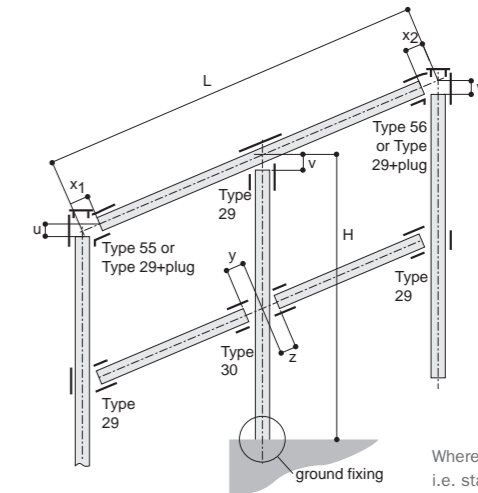

Where the upright remains vertical, i.e. stairways (i) dimension x, y, or z to be subtracted from the upright centres: dimension (L), to give the rail length; (ii) dimension u, v and w for determining the upright length.

Table 6

Rails

Angle of Slope	Size 6 Fitting			Size 7 Fitting			Size 8 Fitting		
	x (mm)	y (mm)	z (mm)	x (mm)	y (mm)	z (mm)	x (mm)	y (mm)	z (mm)
30°	-31	-54	-36	-40	-64	-41	-45	-77	-54
35°	-34	-51	-39	-44	-61	-44	-50	-73	-57
40°	-37	-48	-42	-48	-57	-48	-55	-64	-61
45°	-43	-45	-45	-54	-53	-52	-61	-65	-66

Table 6 gives details of dimensions required for calculating the rail lengths, where angles are between 30° and 45°.

Table 7

Uprights

Angle of Slope	Size 6 Fitting			Size 7 Fitting			Size 8 Fitting		
	u (mm)	v (mm)	w (mm)	u (mm)	v (mm)	w (mm)	u (mm)	v (mm)	w (mm)
30°	+36	-31	+24	+44	-40	+29	+46	-45	+33
35°	+42	-34	+18	+52	-44	+21	+55	-50	+24
40°	+49	-37	+11	+61	-48	+12	+65	-55	+14
45°	+58	-43	+2	+71	-54	+2	+77	-61	+2

Table 7 gives details of dimensions required for calculating the upright lengths, where angles are between 30° and 45°.

Table 8

Uprights and rails using Types 55 and 56 – Size 8 only

Angle	u (mm)	x ₁ (mm)	w (mm)	x ₂ (mm)
20° to 29°	-18	-18	-50	-50
30° to 39°	-16	-16	-60	-60
40° to 49°	-14	-14	-70	-70
50° to 59°	-12	-12	-	-
60° to 69°	-10	-10	-	-
70° to 79°	-8	-8	-	-
80° to 88°	-6	-6	-	-

Table 8 gives details of dimensions required for calculating the upright lengths.

Shelving

Using Type 46 or L46

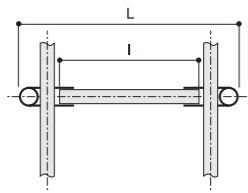

Table 9

Shelving with carrying rails positioned on the outside of the upright

Fitting Size	x (mm)
4	-98
5	-134
6	-162
7	-196
8	-228
9	-276

Table 9 gives the dimension 'x' to be subtracted from overall shelf width 'L' to give the length of the cross rail in the formula $l = L - x$. (Dimension x accounts for the use of two Type 46 or L46 fittings.)

Construction of Braces and Struts

Using Types C50, C51, C52 and C53 or LC50, LC51 and LC52

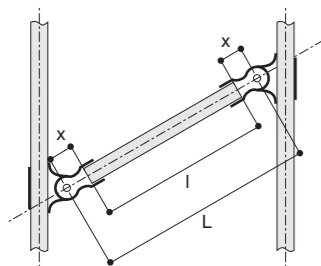

When using multiple tube sizes in one structure, Types F50-5 to F50-9 or LF50-6 to LF50-8 can all be combined with:
 M50-5 to M50-9 LM50-6 to LM50-8
 M51-5 to M51-9 LM50-6 to LM50-8
 M52-5 to M52-8 LM52-6 to LM52-8
 M53-8
 to construct combination fittings (i.e. C50-75, C50-85, C51-655, C52-855 and C53-888).

Table 10

Shelving with carrying rails positioned on the outside of the upright.

Fitting Size	x (mm)
4	-14
5	-25
6	-25
7	-25
8	-25
9	-32

Table 10 gives details of dimension 'x' to be subtracted to give the tube length required for use with two Type F50 or LF50 fittings in the formula $l = L - 2x$.

Note: Dimension 'L' is the length from pivot point to pivot point. The distance from upright to upright is dependent on the angle of the strut.

Pallet Racking

Using Type 46 or L46

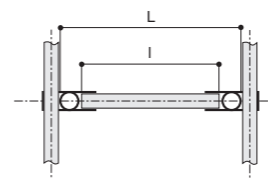

Table 11

Pallet racking with the carrying rails on the inside of the upright

Fitting Size	x (mm)
4*	-48
5*	-59
6*	-72
7	-85
8	-102
9	-126

Table 11 gives dimension 'x' which must be subtracted from the overall width of the carrying rails, to give the length of the cross rail in the formula: $l = L - x$. (Dimension x accounts for the use of two Type 46 or L46 fittings.)

*Pallet racking is not recommended in less than size 7 tube.

Table 12

Additional tube length to reach topmost fitting's termination

Fitting Size	z (mm)
3	+24
4	+28
5	+31
6	+38
7	+46
8	+51
9	+61

The length of the longitudinal member can be calculated from multiples of the length of the bay between the centres of uprights, plus dimension 'z' in Table 12. Dimension z accounts for the length of tube needed to go through the topmost fitting to the fitting's termination. This also applies to constructions using fitting Type 45.

Longitudinal tubes are joined using fittings Type 14 or 18 couplings (use of Type 18 is not recommended as a load bearing joint), which must be positioned to occur at the edge of the Type 46 fitting, and must not all occur in the same bay at alternate levels.

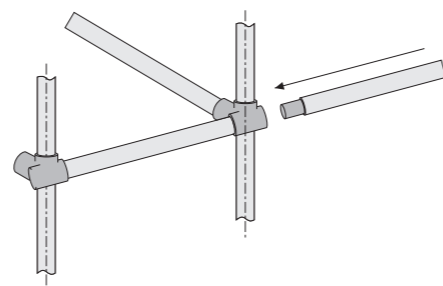

Spigots can be either tubes or rods, riveted into position, or the Type 18 fitting. When using the latter, a gap of 20mm must be allowed for the set screw fixing.

Base and Wall Fixings*

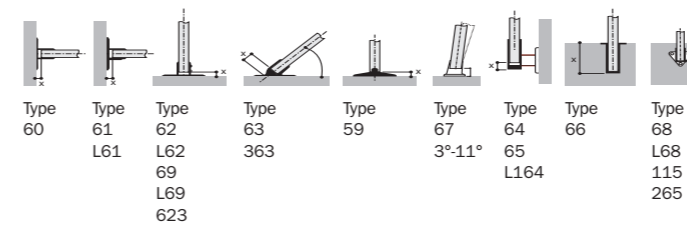

Table 13

Flange Type	x (mm)
59	-10
60	-10
61	-6
62	-6
67	-6
623	-12

Table 13 gives details of the ground fixing dimension 'x', to be subtracted from the height 'H' to give the length of the upright 'h'.

Table 14

Angle	x (mm)
45°	-38
50°	-32
60°	-25
65°	-12

Table 14 gives details of the ground fixing dimension 'x', for Type 63-6 only, to be subtracted to give the length of the upright for each angle condition.

Table 15

Angle	x (mm)
11°	-38
15°	-32
20°	-25
25°	-20
30°	-12

Table 15 gives details of the ground fixing dimension 'x' for Type 363, to be subtracted to give the length of the upright for each angle condition.

Table 16

Fitting Size	x (mm)
6	-5
7	-6
8	-6

Table 16 gives the dimension 'x' to be subtracted from the length of the upright for fitting Types 64, 65, 67, 68, 115, 265, L68 and L164.

Table 17

Fitting Size	x (mm)
6	+115
7	+127
8	+127

Table 17 gives the ground fixing dimension 'x', to be added to the upright member to allow for the setting into the socket Type 66.

*When using Kee Lite bases and flanges, "ground fixing" dimension (x) will be zero, except when using flanges L164, L68 and LC58.

Constructing Circles and Triangles

Worked Example

Slopes and radii present no problem to the Kee Klamp galvanised railing systems. Fitting Types 27, 28, 29, 30, C50, C51, C52, 55, 56, 86, 87, 88 and 89 (and the 90 range pedestrian guardrail fittings) are designed to allow for raked handrail while keeping the uprights vertical. Tube can be bent and radiused to suit most situations. Also, true lengths have to be determined where braces and struts are being used.

Consider the following concrete single flight staircase.

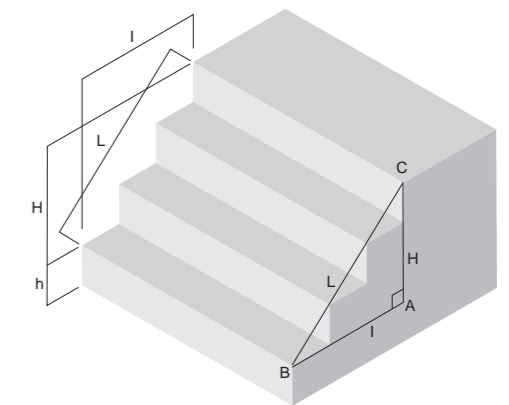

Where

H = Vertical height from 1st nosing to last nosing.

h = Vertical height from ground level to 1st nosing.

I = Horizontal dimension from 1st nosing to last nosing.

L = Hypotenuse dimension (Pitch Line) from 1st nosing to last nosing.

Known Data	Formula for Side and Angle		
H & L	$I = \sqrt{L^2 - H^2}$	$\sin B = \frac{H}{L}$	$C = 90^\circ - B$
L & I	$H = \sqrt{L^2 - I^2}$	$\sin C = \frac{H}{L}$	$B = 90^\circ - C$
H & I	$H = \sqrt{H^2 - I^2}$	$\tan B = \frac{H}{I}$	$C = 90^\circ - B$

Note: The table can be used to solve angles and true lengths for braces and struts.

Step 1

From a simple site survey or information from a working drawing, obtain the following dimensions.

Note: For greater accuracy, vertical dimensions should be taken by means of a Dumpy Level or a Theodolite.

H = vertical height from the 1st nosing to the last (140cm).

L = pitch line, the diagonal dimension from the 1st nosing to the last (240cm).

Step 2

From the table to determine angle B we use;

$$\sin B = 55 / 96, \text{ Angle } B = 35^\circ$$

Ramps can be dealt with in a similar way. Most ramps have a stated gradient (e.g. 1:12); for every 12 units traversed horizontally, 1 unit of vertical height is obtained.

How to Make Jigs for Railing Posts

Set-up

Step 1

Start with pre-cut tube.

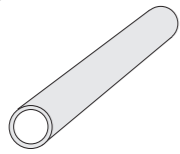

Step 2

Measure and locate fittings on first post only.

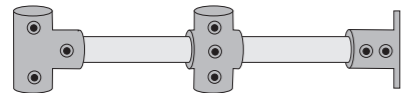

Step 3

Lay post horizontal, and insert two pieces of scrap tube. This is all that's involved in setting up your jig! From this point, duplicate posts can be produced by unskilled labour, without further measuring, at the rate of 20-30 posts per hour.

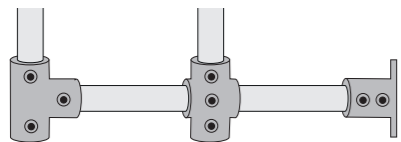

Utilising Jigs for Railing Posts

Production

Step 1

Set top and middle fittings in place, unfastened, on the two pieces of scrap pipe.

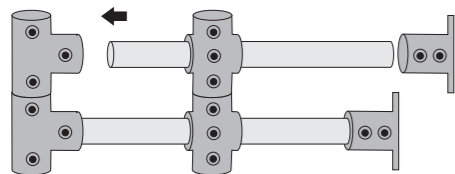

Step 2

Insert pre-cut tube into fittings, then add flange.

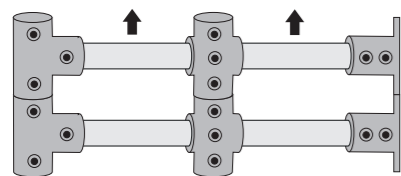

Step 3

Simply tighten set screws, then lift off.

Pedestrian Guardrailing

Using Types 90, 91, 92, 93 and 95

This construction is used when individual rails are required to be removable and when the site is not straight and level. Slopes of up to 7° or radii greater than six metres can be accommodated without bending the tubing.

When bending the tube around a corner, a Type 95 PGR spigot must be included to prevent sagging. Holes of 15mm diameter must be drilled through both walls of the upright, one at 25mm from the top of the upright tube.

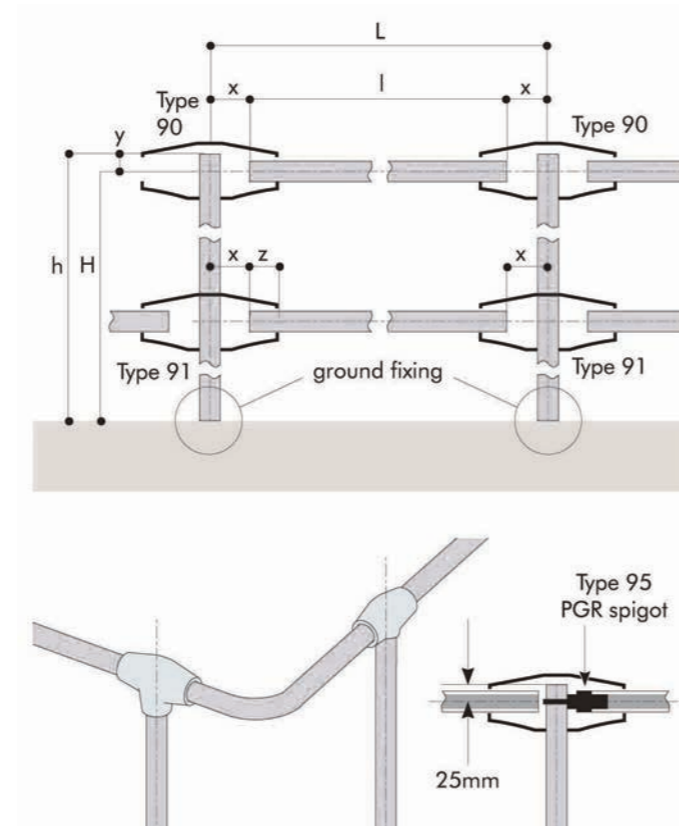

Table 18

Fitting Size	x (mm)	y (mm)
8	-66	+25

Table 18 gives details of:

(i) Dimension 'x' in the formula $l = L - 2x$ for calculating the rail lengths where:

L = distance between the centres of the uprights

l = length of the horizontal tube.

(ii) Dimension 'y' in the formula $h = H + y + (\text{ground fixing})$ for calculating the upright length where:

H = distance from ground to the centre line of the top-rail

h = length of upright tube.

brass drive screw (No. 6 x 10mm) is located at dimension 'z', in Table 19, on one end only for each horizontal tube. This positions the horizontal tube within the Kee Klamp fitting to give location relative to the set screws.

Table 19

Fitting Size	z (mm)
8	37

Wire Mesh Infill

Infilling is normally constructed from 50mm x 50mm x 3.2mm, 25mm x 25mm x 3.2mm or 50mm x 25mm x 3.2mm wire mesh welded to a 8mm Rod frame, and is fixed into position using standard Fitting Types 81 and 82. (NB: Types 81 and 82 require cut outs on mesh less than 32mm square.)

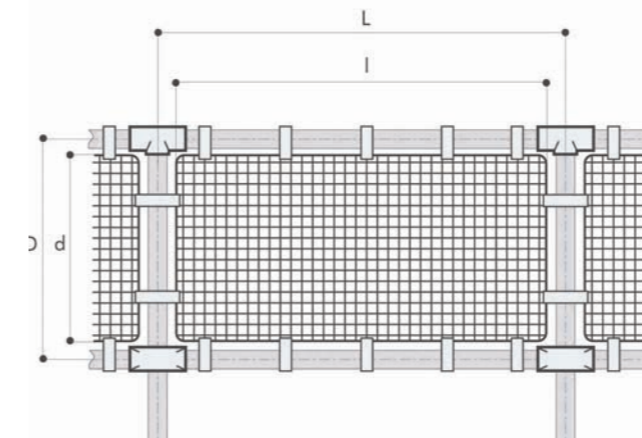

Table 20

Fitting Size	x (mm)
5	-60
6	-76
7	-86
8	-89
9	-98

Table 20 gives the dimensions to be subtracted from the centre dimensions 'L' and 'D' of the structure to give the formulae $l = L - x$ and $d = D - x$.

Warning: The spacing of panel clip Types 81 and 82 should not exceed 450mm centres. The safety attachment incorporated in the panel clip Types 81 and 82 cannot be used with mesh less than 32mm.

Tube Bending

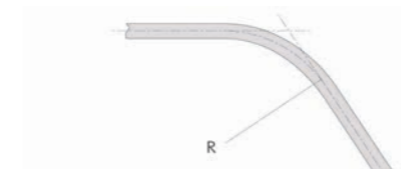

Table 21

Fitting Size	R (mm)
3	57
4	57
5	90 or 98
6	102
7	135
8	152
9	203

Table 21 gives details of standard radius 'R' of the tube bent by Kee Safety Ltd. If the standard radii below are not suitable, tube sizes 5 to 9 can be rolled to any radius above a minimum of 500mm.

Galvanised Racking Load Tables

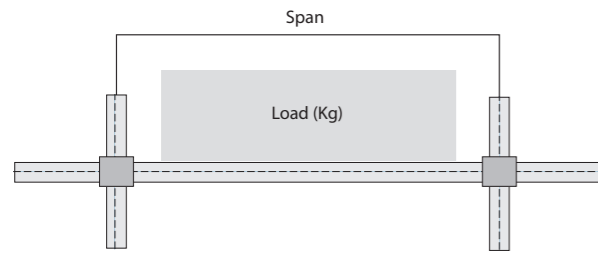

Table 22

Beam load tables (Kg)

Span (m)	Fitting Size				
	5	6	7	8	9
	Tube Size				
	26.9mm x 2.6	33.7mm x 3.2	42.4mm x 3.2	48.3mm x 3.2	60.3mm x 3.6
0.5	540	1060	1750	2380	4000
0.6	435	850	1407	1870	3250
0.7	375	730	1207	1595	2760
0.8	330	645	1063	1385	2420
0.9	295	579	946	1230	2160
1.0	265	525	850	1110	1950
1.1	240	478	770	1013	1775
1.2	219	438	705	930	1625
1.3	202	403	651	858	1497
1.4	187	373	604	796	1387
1.5	175	347	564	741	1290
1.6	-	325	529	693	1205
1.7	-	306	499	650	1129
1.8	-	290	472	613	1061
1.9	-	277	448	581	999
2.0	-	268	427	553	987
2.1	-	-	408	528	944
2.2	-	-	391	505	855
2.3	-	-	376	485	818
2.4	-	-	362	467	785
2.5	-	-	349	450	755
2.6	-	-	-	434	728
2.7	-	-	-	419	703
2.8	-	-	-	405	680
2.9	-	-	-	-	659
3.0	-	-	-	-	639
3.1	-	-	-	-	620
3.2	-	-	-	-	603
3.3	-	-	-	-	588
3.4	-	-	-	-	575
3.5	-	-	-	-	564

Table 22 gives an indication only of the safe load, uniformly distributed, in Kg, that may be carried per shelf consisting of front and back pipes when used as continuous beams. For uneven load distributions or single spans, the required tube size must be determined by standard bending moment calculations assuming a Kee Klamp joint to give a simply supported beam.

At loads greater than 900Kg consideration must be given to set screw slip.

Table reflects a safety factor of 1.67:1

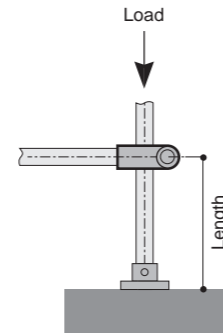

Table 23

Load table (Kg) – unfixed upright

Length (m)	Fitting Size				
	5	6	7	8	9
	Tube Size				
	26.9mm x 2.6	33.7mm x 3.2	42.4mm x 3.2	48.3mm x 3.2	60.3mm x 3.6
0.3	1720	2950	4038	4783	7044
0.4	1435	2617	3703	4446	6661
0.5	1150	2284	3368	4109	6278
0.6	910	1951	3033	3772	5895
0.7	725	1618	2690	3435	5512
0.8	590	1348	2363	3098	5129
0.9	480	1128	2028	2761	4746
1.0	-	948	1752	2424	4363
1.1	-	798	1524	2134	3980
1.2	-	-	1340	1884	3597
1.3	-	-	1188	1668	3253
1.4	-	-	1066	1484	2951
1.5	-	-	-	1328	2681
1.6	-	-	-	-	2441
1.7	-	-	-	-	2226
1.8	-	-	-	-	2032
1.9	-	-	-	-	1857
2.0	-	-	-	-	1697

Table 23 gives an indication only of the safe load, in Kg, that may be carried between the above restraints by single tubes to BS EN 10255 (ISO 65) when used as uprights.

Table reflects a safety factor of 2:1

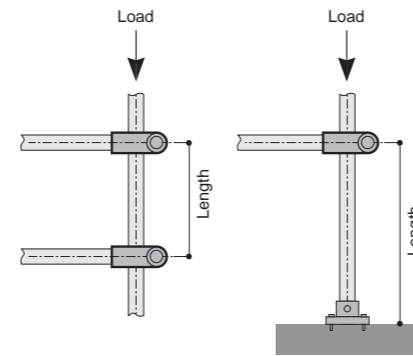

Table 24

Load tables (Kg) – fixed uprights

Length (m)	Fitting Size				
	5	6	7	8	9
	Fitting Size				
	26.9mm x 2.6	33.7mm x 3.2	42.4mm x 3.2	48.3mm x 3.2	60.3mm x 3.6
0.3	1860	3086	4192	4916	7250
0.4	1600	2810	3910	4638	6930
0.5	1360	2534	3628	4360	6610
0.6	1140	2258	3346	4082	6290
0.7	940	1982	3064	3804	5970
0.8	775	1706	2782	3526	5650
0.9	640	1471	2500	3384	5330
1.0	540	1269	2235	3248	5010
1.1	-	1092	1995	2970	4690
1.2	-	937	1779	2692	4370
1.3	-	-	1587	2414	4050
1.4	-	-	1417	2169	3730
1.5	-	-	1265	1954	3410
1.6	-	-	1130	1764	3130
1.7	-	-	-	1602	2890
1.8	-	-	-	1462	2680
1.9	-	-	-	1342	2480
2.0	-	-	-	1242	2300
2.1	-	-	-	-	2120
2.2	-	-	-	-	1950
2.3	-	-	-	-	1800
2.4	-	-	-	-	1650

Table 24 (on page 49) gives an indication only of the safe load, in Kg, that may be carried between the above restraints by single tubes when used as uprights.

At loads greater than 900Kg* consideration must be given to set screw slip (*rating includes a safety factor of 2:1.74).

Table reflects a safety factor of 2:1

Aluminium Racking Load Tables

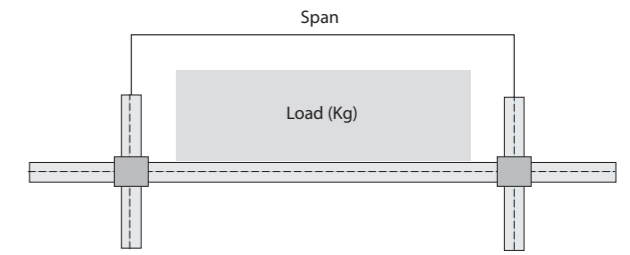

Table 25

Beam load table (Kg)

Span (m)	Fitting Size			
	6	7	8	9
	Tube Size (mm)			
	25 N.B.	32 N.B.	40 N.B.	50 N.B.
	Grade of Material – 6082 T6 Aluminium			
0.3	1140	2468	4230	8693
0.6	285	617	1057	2173
0.9	126	274	470	965
1.1	84	183	314	646
1.2	71	154	264	543
1.5	45	98	169	347
1.7	35	76	131	270
2.1	23	50	86	177
2.3	-	42	71	147
2.4	-	38	66	135
2.7	-	-	52	107
3.0	-	-	42	86

Values shown have a safety factor of 2 built into them and are based on the limit state of the material used.

The values in Table 25 are an indication of a UDL that a rack consisting of two continuous support tubes can support.

For uneven load distributions, the required tube size must be determined by standard bending moment and deflection calculations assuming the Kee Lite joint to give a simply supported beam.

At loads greater than 770Kg* consideration must be given to grubscrew slippage. (*A safety factor of 2 being applied in this instance.)

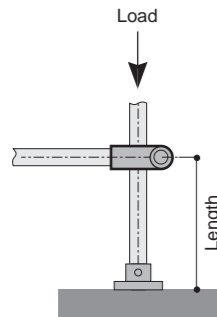

Table 26
Load tables (Kg) – unfixed upright bases

Height (m)	Fitting Size			
	6	7	8	9
	Tube Size (mm)			
	25 N.B.	32 N.B.	40 N.B.	50 N.B.
	Grade of Material – 6082 T6 Aluminium			
0.30	2431	4174	5249	7382
0.40	1653	3470	4593	6994
0.45	1296	2636	3675	6640
0.50	891	1977	3150	5934
0.60	502	1538	2441	5122
0.70	405	1274	1969	3850
0.75	324	725	1706	3355
0.80	267	593	1260	2755
0.90	251	505	1129	2402
1.00	210	461	997	2048
1.05	178	395	525	1942
1.10	-	351	499	1589
1.20	-	329	394	1448
1.30	-	308	381	1271
1.40	-	285	357	742
1.45	-	-	314	600
1.50	-	-	276	557
1.60	-	-	-	530
1.67	-	-	-	466
1.75	-	-	-	441
1.80	-	-	-	406
1.90	-	-	-	369
2.00	-	-	-	351

Values shown have a safety factor of 2 built into them and are based on the limit state of the material used.

Table 26 gives an indication only of the safe load, in Kg, that may be carried between the above restraints by single tubes when used as uprights.

Table reflects a safety factor of 2:1

At loads greater than 770Kg consideration must be given to grubscrew slippage (a safety factor of 2 being included in this instance).

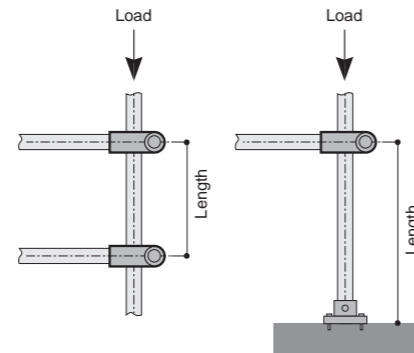

Table 27
Load tables (Kg) – uprights restrained both ends

Height (m)	Fitting Size			
	6	7	8	9
	Tube Size (mm)			
	25 N.B.	32 N.B.	40 N.B.	50 N.B.
	Grade of Material – 6082 T6 Aluminium			
0.30	3549	5052	6063	8300
0.40	3371	4789	5906	8123
0.45	3160	4723	5722	8053
0.50	2625	4393	5512	7841
0.60	2399	4174	5249	7700
0.70	2009	3778	5118	7417
0.75	1750	3405	4803	7064
0.80	1378	2965	4147	6994
0.90	1215	2592	3622	6605
1.00	1102	2240	3360	6181
1.05	940	1933	3097	5828
1.10	843	1845	2703	5474
1.20	-	1538	2493	5122
1.30	-	1427	2231	4768
1.40	-	1318	1969	3956
1.45	-	1208	1785	3814
1.50	-	1076	1627	3461
1.60	-	988	1522	3108
1.67	-	-	1443	2755
1.75	-	-	1286	2543
1.80	-	-	1181	2402
1.90	-	-	-	2296
2.00	-	-	-	2155
2.05	-	-	-	2048
2.10	-	-	-	1801
2.20	-	-	-	1730
2.30	-	-	-	1589
2.40	-	-	-	1519

Values shown have a safety factor of 2 built into them and are based on the limit state of the material used.

Table 27 gives an indication only of the safe load, in Kg, that may be carried between the above restraints by single tubes when used as uprights.

Table reflects a safety factor of 2:1

At loads greater than 770Kg consideration must be given to grubscrew slippage (a safety factor of 2 being included in this instance).

Test Report:
Vibration of Kee Klamp® Assemblies

Exhaustive tests on samples of standard size 7 Kee Klamp fittings were performed by an independent research laboratory. The purpose of the test was to evaluate the use of either standard set screws or self-locking set screws.

Test Arrangement

A “Tee” section test assembly was made using three 300mm lengths of galvanised size 7 standard tube held together by a three socket tee fitting (Type 25-7). The vertical leg of the test assembly was supported in a standard railing flange (Type 62-7). The completed assembly was then rigidly attached to the vibration table.

The test assembly was initially assembled using standard set screws and tested in this configuration. The standard set screws were then replaced with the self-locking screws and the tests repeated.

Test Procedure

The test was conducted on a Ling 667Kg Electromagnetic Vibration Table. The table was programmed to perform a resonance search between 25 and 350Hz and resonant frequencies were recorded and shown in Table 28.

Table 28
Test Results

Resonance Frequencies	Q Factor	Running Time
74	1.27	Nil
106	1.27	Nil
158	1.53	6 hours
200	1.8	6 hours
221	5	6 hours
295	9	6 hours

During the resonance search, amplification factors (Q) were measured at each resonant frequency, the point of reference being the end of one horizontal tube. The table was then held at one of the resonant frequencies, set in motion with a controlled acceleration level of 4g, and ran for a period of six hours. This was repeated for three more resonant frequencies in descending order of Q factor.

Furthermore, during the twenty-four hours of vibration at the four resonant frequencies above, no signs of loosening with either type of attachment screw occurred.

Comprehensive data showing the telescopic relationship between tubes to BS EN 10255 (ISO 65) is shown in Table 29.

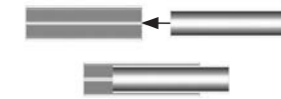

Table 29
Telescopic relationship between tubes to BS EN 10255 (ISO 65)

Size 9 heavy	Will accept 8 heavy or medium
Size 9 medium	Will accept 8 heavy or medium
Size 8	No telescopic relationship Requires special spigotting material
Size 7 heavy	Will only accept size 6 light
Size 7 medium	Will accept size 6 light, medium and heavy
Size 6 heavy	No telescopic relationship Requires special spigotting material
Size 6 medium	Will only accept size 5 light
Size 5 heavy	No telescopic relationship Requires special spigotting material
Size 5 medium	No telescopic relationship Requires special spigotting material
Size 4	No telescopic relationship Requires special spigotting material
Size 3	No telescopic relationship Requires special spigotting material



Visit our website



Kee Safety Limited
Cradley Business Park
Overend Road
Cradley Heath
West Midlands
B64 7DW
United Kingdom

Tel: +44 (0) 1384 632 188

Email: sales@keesafety.com

Web: www.keesafety.co.uk

KEE KLAMP and KEE LITE are registered trademarks of Kee Safety Ltd. Whilst every effort has been made to ensure the accuracy of the information contained in this brochure, Kee Safety Ltd cannot be held responsible for any errors or omissions. Kee Safety Ltd reserves the right to alter or withdraw products without prior notice. Kee Safety Ltd accepts no responsibility for any loss or damage arising from improper use of its products. Copyright © 2023 Kee Safety Ltd. All Rights Reserved.