



SAFETY AT THE HIGHEST LEVEL

Kee Anchor Operation & Maintenance Manual







INTRODUCTION

The CE Approved Weightanka® is a Portable Deadweight Anchor device which is an item of Personal Protective Equipment (PPE). Weightanka® has been specifically designed to provide short term safety for low frequency operations where collective protection is not provided. The unit is ideal for short term maintenance operations to flat roofs or to the plant and equipment installed at roof level such as AC units, telecommunications equipment etc. Weightanka® is extremely compact, portable, and easily assembled.

The Weightanka® has been designed to be used with an approved shock absorbing rope grab and rope and full body harness to provide safe access at all times.

The unit is fully galvanised to BS EN ISO 1461: Hot Dip Galvanised Coatings Specification and test methods. The Rubber Coated Base Weights are supplied with suction cups. These protect the roof membrane, increase friction resistance and enable the anchor to be used on all roof membranes, even in wet weather.

Weightanka® fully complies with Class E of BS EN 795: Protection against falls from height - Anchor devices - Requirements and testing.

The system also conforms to BS7883 - Code of practice for the design, selection, installation, use and maintenance of anchor devices conforming to BS EN 795 & ISO 14567 - Personal protective equipment for protection against falls from a height - Single - point anchor devices, and is approved to meet the PPE Directive.

The unit has also been designed to ensure compliance with the following Regulations:

- Construction (Design & Management) Regulations
- Work at Height Regulations
- Construction (Health, Safety & Welfare) Regulations
- Workplace (Health, Safety & Welfare) Regulations
- Manual Handling Operations Regulations

BUILDING HEIGHT & SAFE WORKING

It is essential that a risk assessment is carried out by a competent person to ensure that the product is used safely. Part of the assessment will consider the building's height and the combination of PPE to be used in conjunction with the Weightanka®.

Kee Safety recommends that, as far as reasonably practicable, the Weightanka® should be used as a fall restraint solution rather than fall arrest. When used for fall restraint, the Weightanka® must be used in conjunction with PPE that prevents the operative from reaching the leading edge. Weightanka® should then be positioned so that the rope remains taught as the user approaches the edge. If the above is not possible and a fall arrest solution is required then a sufficiently detailed risk assessment, method statement and rescue policy must be produced by a competent person. Care must also be taken to use the correct combination of PPE to minimize the distance & consequence of a potential fall.

Kee Anchor System Overview



Generally the length of the shock absorbing rope grab device should not exceed the height of the building in order to avoid the possibility of the pendulum effect. To prevent this, the Weightanka® should be placed perpendicular to the leading edge where the operative is likely to be working. The rope grab line should remain taught at all times when working at the leading edge. No part of the Weightanka® should be placed closer than 2.5m from the nearest roof edge. The unit should not be placed on any surfaces affected by ice, grease or similar slippery conditions which may impair the performance of the unit.

ROOF PITCH & SAFE WORKING

Weightanka® can be used on any flat roof or industrial steel cladded pitched roof up to 15° pitch provided that the unit is positioned on the opposite pitch to where the operative intends to work. When placed on a roof slope, the Weightanka® must be at least 2.5m from the ridge. In all cases, the roof structure must be capable of taking the load of the Weightanka® (250kg base unit) combined with the weight of the operative, plus any additional equipment required.

LEGAL REQUIREMENTS

The Work at Height Regulations 2005 require that the employer/building owner has a rescue plan and policy in place for all fall arrest systems.

TESTING & CE APPROVAL

Kee Safety's Weightanka® has been extensively tested by NEL to BS EN 795: Protection against falls from a height - Anchor devices - Requirements and testing. The unit was tested on the following roof surfaces and has been awarded CE Approval accordingly.

Single Ply Membrane Paving Slabs
HT Mineral Grade Felt Asphalt
Swept Stone Chippings Steel Cladding

EN 795 TEST PROCEDURE

The test involved a 100kg weight freefalling a distance of 2.5m to reach a force of 25kN. The Mobile Man Anchor then had to bring this force to a complete rest within a horizontal movement not exceeding 1.0m. This was achieved via the partial deformation of the Top & Bottom Cross Frame. Full independent test documentation is available upon request.

EN 795 REVIEW

This standard has recently been reviewed and published in 2012. Unfortunately this new version has not been harmonised and is not listed on the official journal. Therefore test houses are unable to provide CE certificates to this new version of the standard. The new version remains very similar and the 100kg test weight remains unchanged, but the free fall distance has been changed and test houses have to calculate this to generate a 9kN force.

Once this dynamic load has been applied an additional 200kg static load is applied, thus representing an extreme rescue situation where a rescuer has no choice but to abseil to the casualty.

(Kee Safety does not recommend connecting a second person (fall arrest) to the system under any circumstances, including in the event of a rescue)

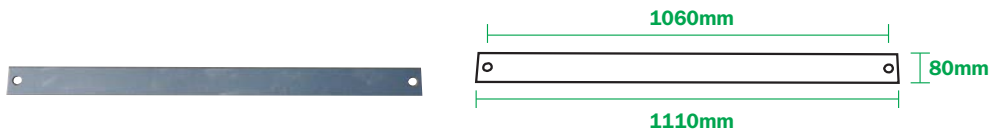

STABILISER ARM – DW1014010

The Stabiliser Arm is placed on top of adjacent Rubber Coated Base Weights prior to fitting Top and Bottom Cross Arms.

Material : galvanised steel to BS EN ISO 1461. Net weight : 3.5kg.

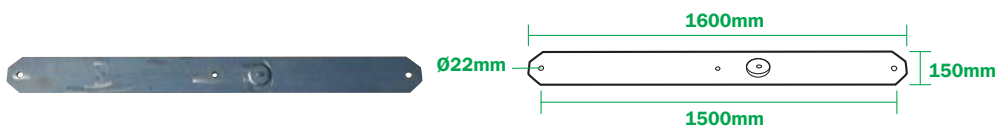

BOTTOM CROSS ARM – DW1015B10

The Bottom Cross Arm is used to connect the Base Weights.

This cross arm has a threaded spreader plate to accept the pedestal fixing bolt. A second tapped hole and spreader plate is provided for use as a restraint anchor point.

Material : galvanised steel to BS EN ISO 1461. Net weight : 16kg.

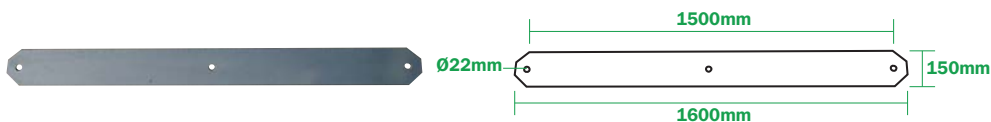

TOP CROSS ARM – DW1015T10

The Top Cross Arm is used to connect the Base Weights.

Material : galvanised steel to BS EN ISO 1461. Net weight : 15kg.



TOMMY BAR – DWATBAR10

For use when tightening the eyebolt into the pedestal. The length and diameter of the tommy bar is specially designed to apply the correct force when tightening the eyebolt. The tommy bar should ONLY be used with the eyebolt centrally positioned and with one hand turning each end. NEVER use the tommy bar with the eyebolt positioned at one end as this would result in too much force being applied which could damage the eyebolt.

Material : galvanised steel to BS EN ISO 1461. Net weight : 0.15kg.

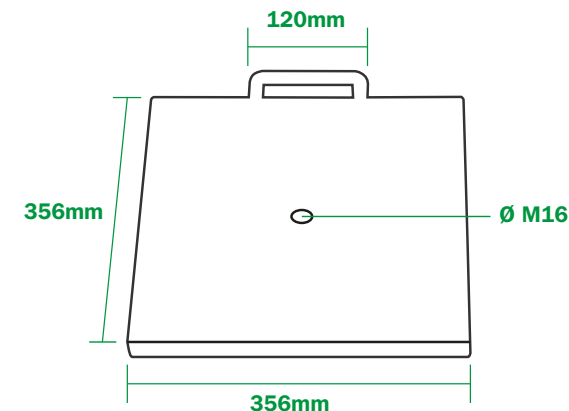

RUBBER COATED BASE WEIGHTS – DW1013010

These base weights provide the maximum friction with the roof membrane. Each Rubber Coated Base Weight has a centrally tapped hole to accept the Weight Locating Pin.

Material : galvanised steel to BS EN ISO 1461. Net weight : 16kg.

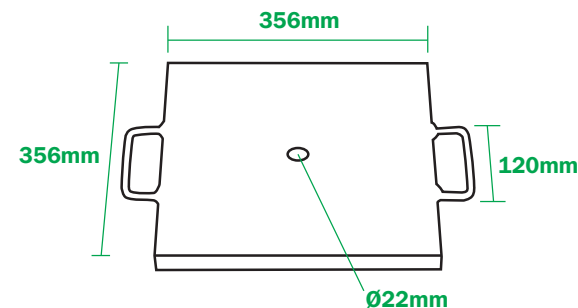

STANDARD WEIGHT – DW1012010

The standard weights are Galvanised. The central hole of the standard weights is un-threaded, and designed to accept the unthreaded portion of the Weight Locating Pin. IT IS ESSENTIAL THE CORRECT NUMBER OF WEIGHTS ARE USED DEPENDENT UPON ROOF MEMBRANE.

Material : galvanised steel to BS EN ISO 1461. Net weight : 25kg.

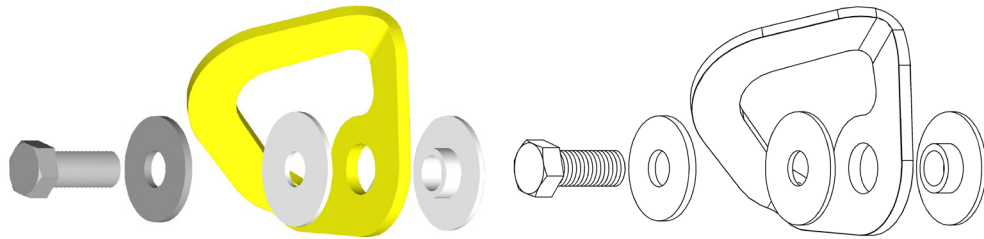

Type 'A' Anchor device **SECONDARY ATTACHMENT POINT** – LAKL2SPAP

An M12 threaded eyebolt, screwed into the secondary fixing location on the cross arm to which the second user's personal protection system (e.g.lanyard) must be attached for restraint only
Material : Stainless steel grade 316. Net weight : 0.22kg.

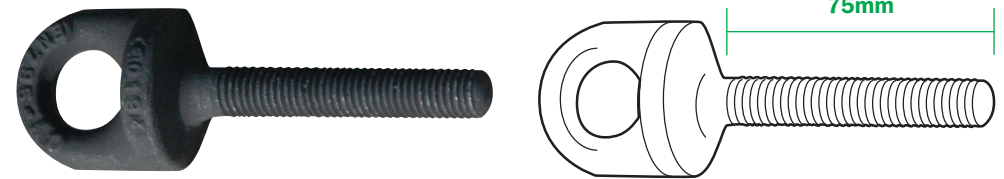

Type 'A' M12 X 75 Eye-Bolt -EN0075G10

An M12 threaded eyebolt,screwed into the top of the central pedestal to which the user's personal protection system
Material : Drop forged galvanised to BS EN ISO 1461. Net weight : 0.1.9kg.

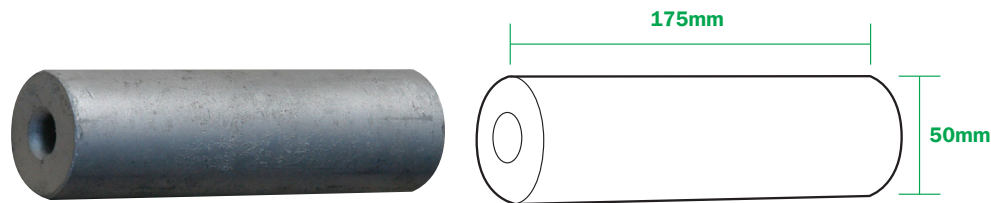

PEDESTAL – DW1018010

The central pedestal provides the connection point for the user. The lower end of the central pedestal has an M20 threaded hole to accept the socket screw. The upper end of the pedestal has an M12 tapped hole to accept the class A1 eyebolt used as the attachment point.
Material : galvanised steel to BS EN ISO 1461. Net weight : 2.5kg.

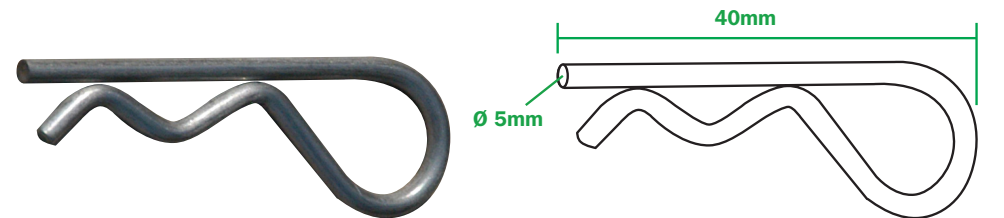

SECURING R CLIP – DWACL101

The 'R' clip type securing pins used to prevent accidental release of the standard weights from the Weight Locating Pins. The securing pins are fitted after all necessary standard weights have been fitted Fit the securing pins into the first visible hole of the weight locating pin nearest to the top standard weight
Material : galvanised steel to BS EN ISO 1461. Net weight : 0.15kg. (Quantity 4No)

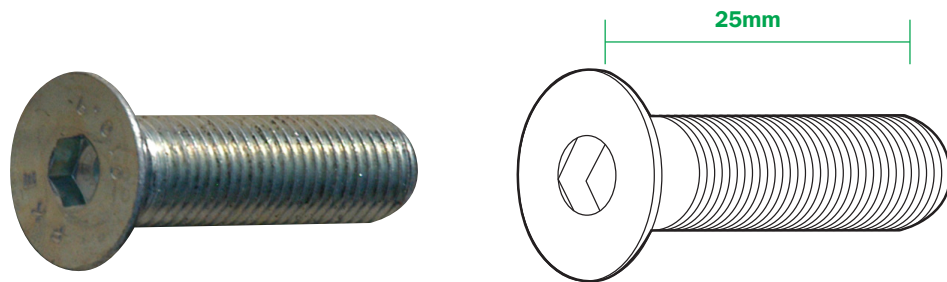

ZINC PLATED SOCKET SCREW - DWM207570

This is used to connect the pedestal to the Bottom Cross Arm. M20 x 25mm CSK Screw. The socket screw is screwed through the Bottom Cross Arm such that it passes through the spreader plate BEFORE passing through the Bottom Cross Arm.
Material : zinc plated. Net weight : 0.2kg.

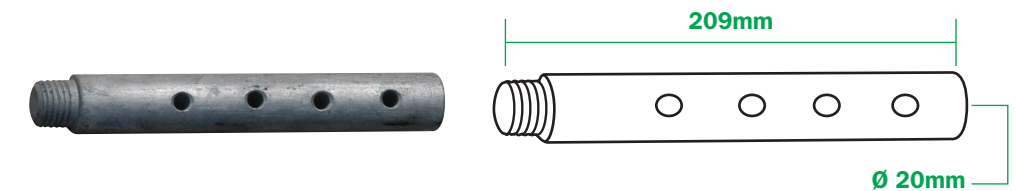

WEIGHT LOCATING PIN – DW1016010

These locating pins screw into the central tapped hole of each rubber coated base weight and provide the locating position of the Standard Weights.
Material : galvanised steel to BS EN ISO 1461. Net weight : 1.3kg (Quantity 4No).

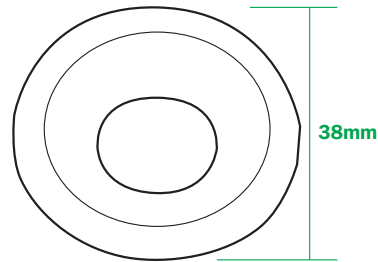

POLYTHENE WASHER - PWH003840

This washer is positioned between the warning disc and the pedestal
Material : PVC. Net weight : 0.002kg.

HEAD OFFICE
Kee Safety Limited
Cradley Business Park
Overend Road
Cradley Heath
West Midlands B64 7DW

(t) +44 (0) 1384 632 188
(f) +44 (0) 1384 632 192
(e) info@keesafety.co.uk
(w) www.keesafety.co.uk

**Please make sure you have read the User Instructions
before using this equipment**

INSPECTION DATE	/ /	/ /	/ /	/ /
-----------------	-----	-----	-----	-----

SYSTEM PLAQUE - SL 111

Provides details of the system and approvals. Material : Plastic. Net weight : 1/3 oz.

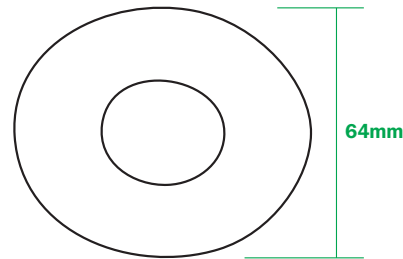

PPE WARNING DISC - PP00FA040 or PP00FR040

Fall Arrest Warning Disc This disc provides information on use and date of test. Positioned under the eyebolt and above the polythene washer.
Material : PVC. Net weight : 0.003kg.

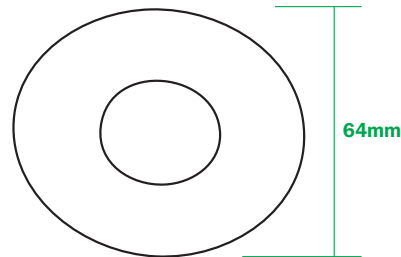

PPE WARNING DISC - PP00FR040

Fall Restraint Warning Disc This disc provides information on use and date of test.. Positioned under the eyebolts on central pedestal secondary fixing location on cross arm and above the polythene washer.
Material : PVC. Net weight : 0,003kg.



PLEASE BE ADVISED: Before assembling the WEIGHTANKA system for the first time, it is highly recommended that Installers familiarise themselves with the component parts and carry out a test assembly and disassembly in a safe area away from the point of final installation. All component parts detailed in the operating instructions must be used in the assembly of the system. Should a piece be missing or appear defective do not continue to assemble and contact Kee Safety Immediately.

STAGE 1.

Lay the rubber coated base weights with suction cups facing downwards onto roof surface approx 1m apart. Ensure that the closeset distance to any edge is not less than 2.5m.

STAGE 2,

Screw the locating pins into the central tapped holes in the rubber coated base plates by hand until it is fully home.

STAGE 3.

Slide the stabiliser arm over the locating pins by adjusting the position of the adjacent Base Plates .

STAGE 4.

Select the base cross arm and screw the M20 x 75 CSK Socket set screw into the centrally located CSK Boss.

STAGE 5.

Slide the Bottom cross arm over diagonally opposite base weight pins ensuring that the threaded portion of the protruding set screw is facing upwards.

STAGE 6.

Slide the Top cross arm over diagonally opposite base weight pins.

STAGE 7.

Screw the pedestal onto the threaded portion in the centre of the two arms until it is fully

STAGE 8.

Place the Galvanised weights over the locating pins. Stack the number of weights according to the application, ensuring that the number of weights on diagonally opposing sides are

STAGE 9.

Place the polyethelene washer on top of the pedestal

STAGE 10.

Place the PPE warning disc on top of the previously located washer and screw the eyebolt into the top of the Pedestal

STAGE 11.

Using the supplied Tommy bar Hand tighten the eyebolt firmly in place until it is fully located.

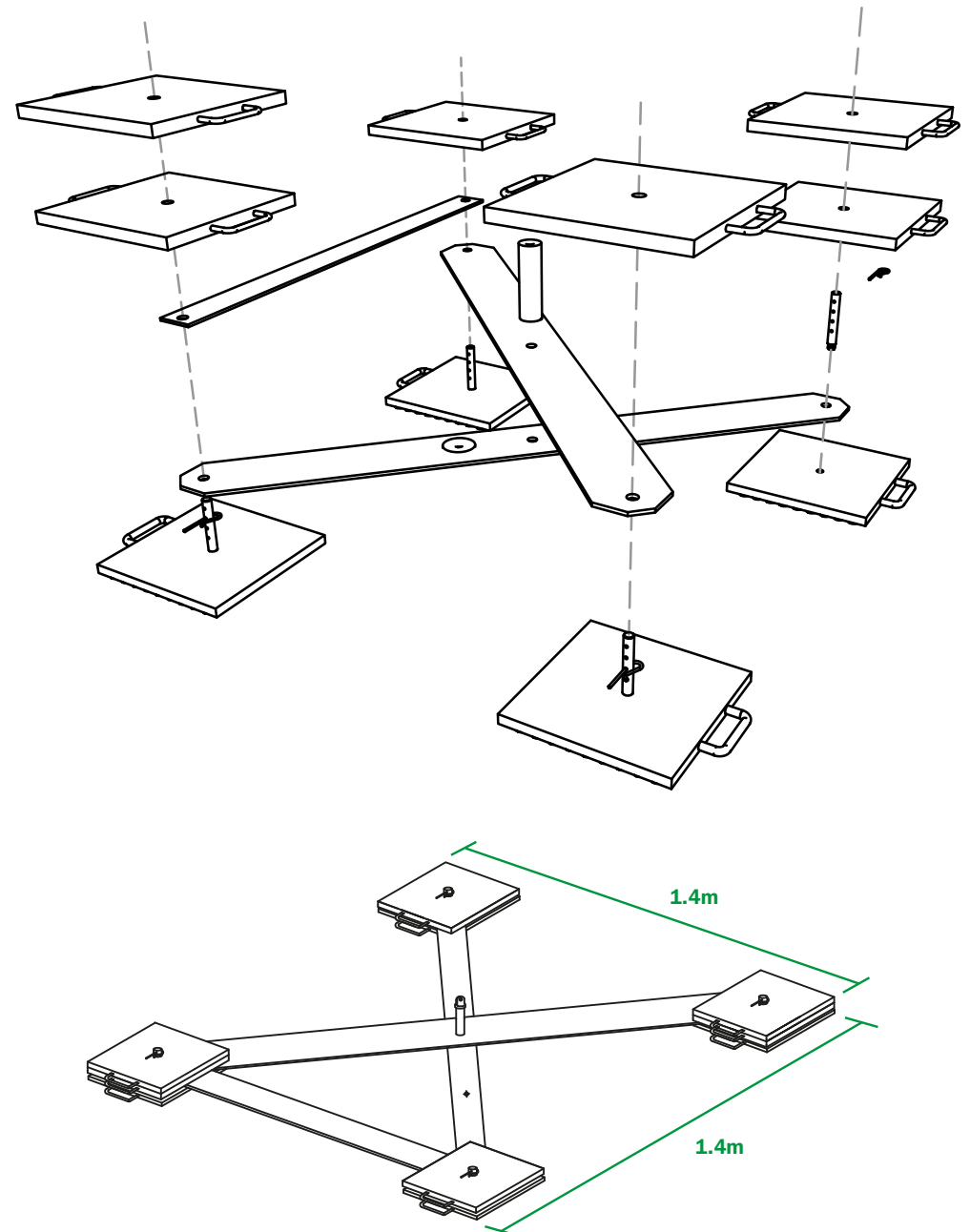

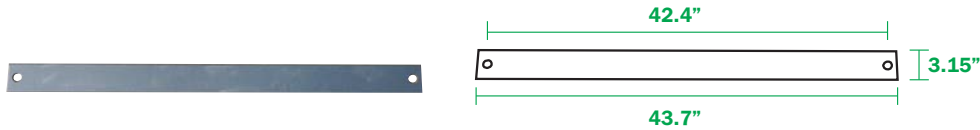

STABILISER ARM – DW1014010

The Stabiliser Arm is placed on top of adjacent Rubber Coated Base Weights prior to fitting Top and Bottom Cross Arms.

Material : galvanised steel to ASTM A53. Net weight : 8lb 8oz

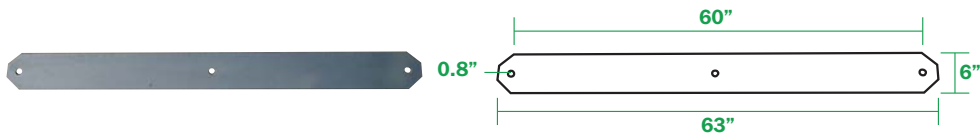

BOTTOM CROSS ARM – DW1015B10

The Bottom Cross Arm is used to connect the Base Weights.

This cross arm has a threaded spreader plate to accept the pedestal fixing bolt. A second tapped hole and spreader plate is provided for use as a restraint anchor point.

Material : galvanised steel to ASTM A53. Net weight : 35lb.

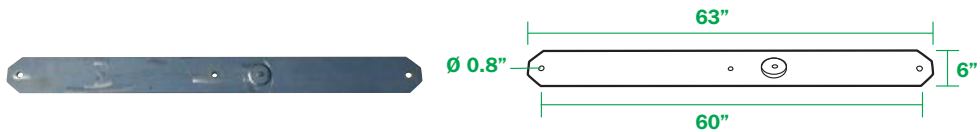

TOP CROSS ARM – DW1015T10

The Top Cross Arm is used to connect the Base Weights.

Material : galvanised steel to ASTM A53. Net weight : 33lb.

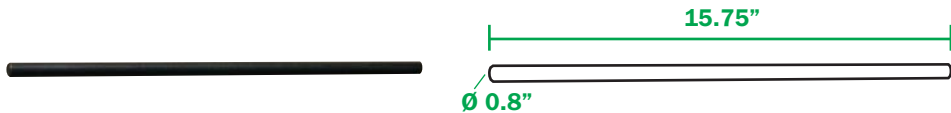

TOMMY BAR – DWATBAR10

For use when tightening the eyebolt into the pedestal. The length and diameter of the tommy bar is specially designed to apply the correct force when tightening the eyebolt. The tommy bar should ONLY be used with the eyebolt centrally positioned and with one hand turning each end. NEVER use the tommy bar with the eyebolt positioned at one end as this would result in too much force being applied which could damage the eyebolt.

Material : galvanised steel to ASTM A53. Net weight : 5.28oz.

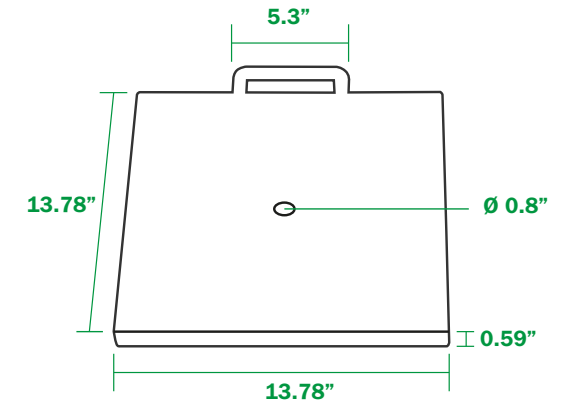

RUBBER COATED BASE WEIGHTS – DW1013010

These base weights provide the maximum friction with the roof membrane. Each Rubber Coated Base Weight has a centrally tapped hole to accept the Weight Locating Pin.

Material : galvanised steel to ASTM A53. Net weight : 35lb 4oz

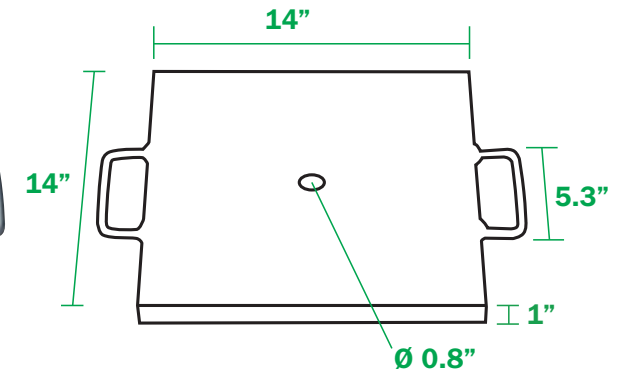

STANDARD WEIGHT – DW1012010

The standard weights are Galvanised. The central hole of the standard weights is un-threaded, and designed to accept the unthreaded portion of the Weight Locating Pin. IT IS ESSENTIAL THE CORRECT NUMBER OF WEIGHTS ARE USED DEPENDENT UPON ROOF MEMBRANE.

Material : galvanised steel to ASTM A53. Net weight : 55lb

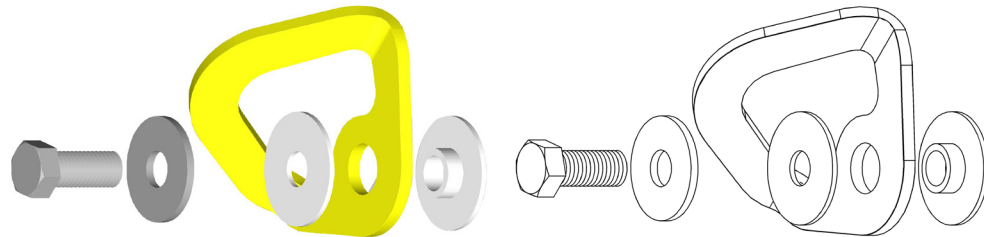

Type 'A' Anchor device **SECONDARY ATTACHMENT POINT** – LAKL2SPAP

An M12 threaded eyebolt, screwed into the secondary fixing location on the cross arm to which the second user's personal protection system (e.g.lanyard) must be attached for restraint only
Material : Stainless steel grade 316. Net weight : 8oz.

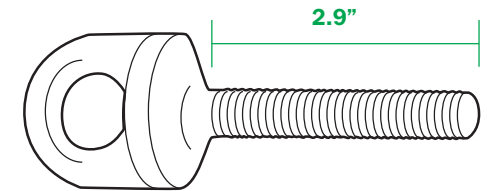
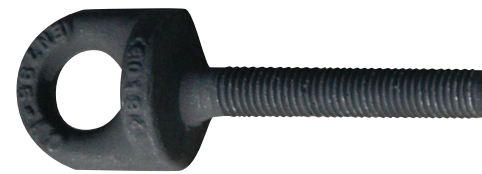

Type 'A' M12 X 75 Eye-Bolt -EN0075G10

An M12 threaded eyebolt, screwed into the top of the central pedestal to which the user's personal protection system
Material : Drop forged galvanised to ASTM A53. Net weight : 7oz.

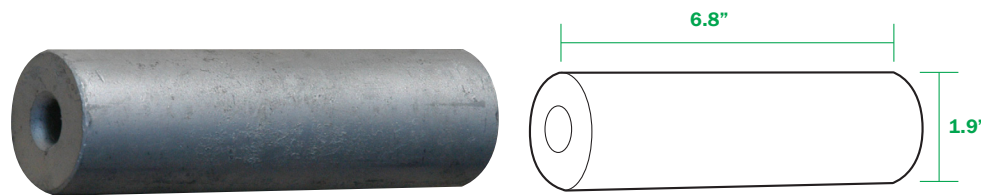

PEDESTAL – DW1018010

The central pedestal provides the connection point for the user. The lower end of the central pedestal has an M20 threaded hole to accept the socket screw. The upper end of the pedestal has an M12 tapped hole to accept the class A1 eyebolt used as the attachment point.
Material : galvanised steel to ASTM A53. Net weight : 5lb 8oz.

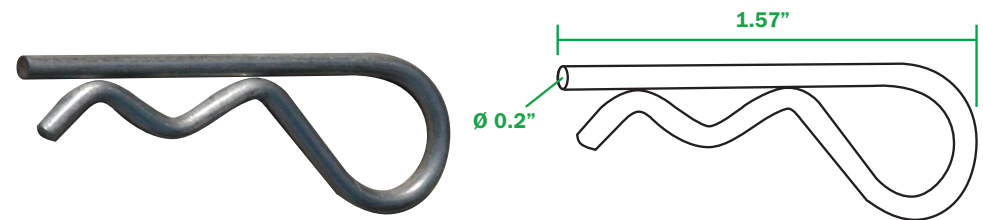

SECURING R CLIP – DWACL101

The 'R' clip type securing pins used to prevent accidental release of the standard weights from the Weight Locating Pins. The securing pins are fitted after all necessary standard weights have been fitted. Fit the securing pins into the first visible hole of the weight locating pin nearest to the top standard weight
Material : galvanised steel to ASTM A53. Net weight : 5.28oz. (Quantity 4No)

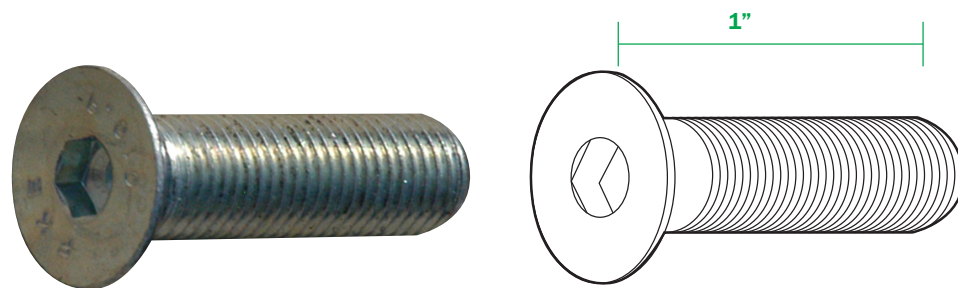

ZINC PLATED SOCKET SCREW - DWM207570

This is used to connect the pedestal to the Bottom Cross Arm. M20 x 25 CSK Screw. The socket screw is screwed through the Bottom Cross Arm such that it passes through the spreader plate BEFORE passing through the Bottom Cross Arm.
Material : zinc plated. Net weight : 7oz.

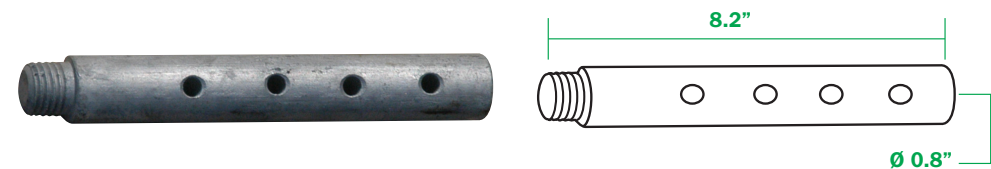

WEIGHT LOCATING PIN – DW1016010

These locating pins screw into the central tapped hole of each rubber coated base weight and provide the locating position of the Standard Weights.
Material : galvanised steel to ASTM A53. Net weight : 2lb 14oz (Quantity 4No).

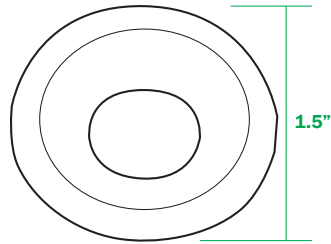

POLYTHENE WASHER - PWH003840

This washer is positioned between the warning disc and the pedestal
Material : PVC. Net weight : 0.075oz.

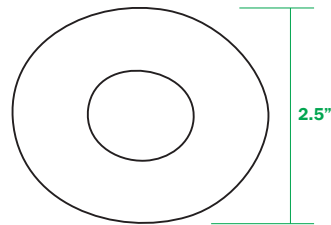

PPE WARNING DISC - PP00FA040 or PP00FR040

Fall Arrest Warning Disc This disc provides information on use and date of test. Positioned under the eyebolt and above the polythene washer.
Material : PVC. Net weight : 0.1oz.

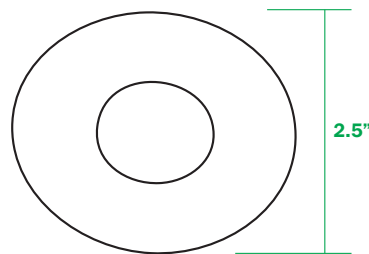

PPE WARNING DISC - PP00FR040

Fall Restraint Warning Disc This disc provides information on use and date of test.. Positioned under the eyebolts on central pedestal secondary fixing location on cross arm and above the polythene washer.
Material : PVC. Net weight : 0.1oz

HEAD OFFICE
Kee Safety Limited
Cradley Business Park
Overend Road
Cradley Heath
West Midlands B64 7DW

(t) +44 (0) 1384 632 188
(f) +44 (0) 1384 632 192
(e) info@keesafety.co.uk
(w) www.keesafety.co.uk

Please make sure you have read the User Instructions before using this equipment

INSPECTION DATE	/ /	/ /	/ /	/ /	/ /	/ /
-----------------	-----	-----	-----	-----	-----	-----

SYSTEM PLAQUE - SL 111

Provides details of the system and approvals. Material : Plastic. Net weight : 1/3 oz.





PLEASE BE ADVISED: Before assembling the WEIGHTANKA system for the first time, it is highly recommended that Installers familiarise themselves with the component parts and carry out a test assembly and disassembly in a safe area away from the point of final installation. All component parts detailed in the operating instructions must be used in the assembly of the system. Should a piece be missing or appear defective do not continue to assemble and contact Kee Safety Immediately.

STAGE 1.

Lay the rubber coated base weights with suction cups facing downwards onto roof surface approx 39" apart. Ensure that the closeset distance to any edge is not less than 98.4".

STAGE 2,

Screw the locating pins into the central tapped holes in the rubber coated base plates by hand until it is fully home.

STAGE 3.

Slide the stabiliser arm over the locating pins by adjusting the position of the adjacent Base Plates .

STAGE 4.

Select the base cross arm and screw the M20 x 75 CSK Socket set screw into the centrally located CSK Boss.

STAGE 5.

Slide the Bottom cross arm over diagonally opposite base weight pins ensuring that the threaded portion of the protruding set screw is facing upwards.

STAGE 6.

Slide the Top cross arm over diagonally opposite base weight pins.

STAGE 7.

Screw the pedestal onto the threaded portion in the centre of the two arms until it is fully

STAGE 8.

Place the Galvanised weights over the locating pins. Stack the number of weights according to the application, ensuring that the number of weights on diagonally opposing sides are

STAGE 9.

Place the polyethelene washer on top of the pedestal

STAGE 10.

Place the PPE warning disc on top of the previously located washer and screw the eyebolt into the top of the Pedestal

STAGE 11.

Using the supplied Tommy bar Hand tighten the eyebolt firmly in place until it is fully located.

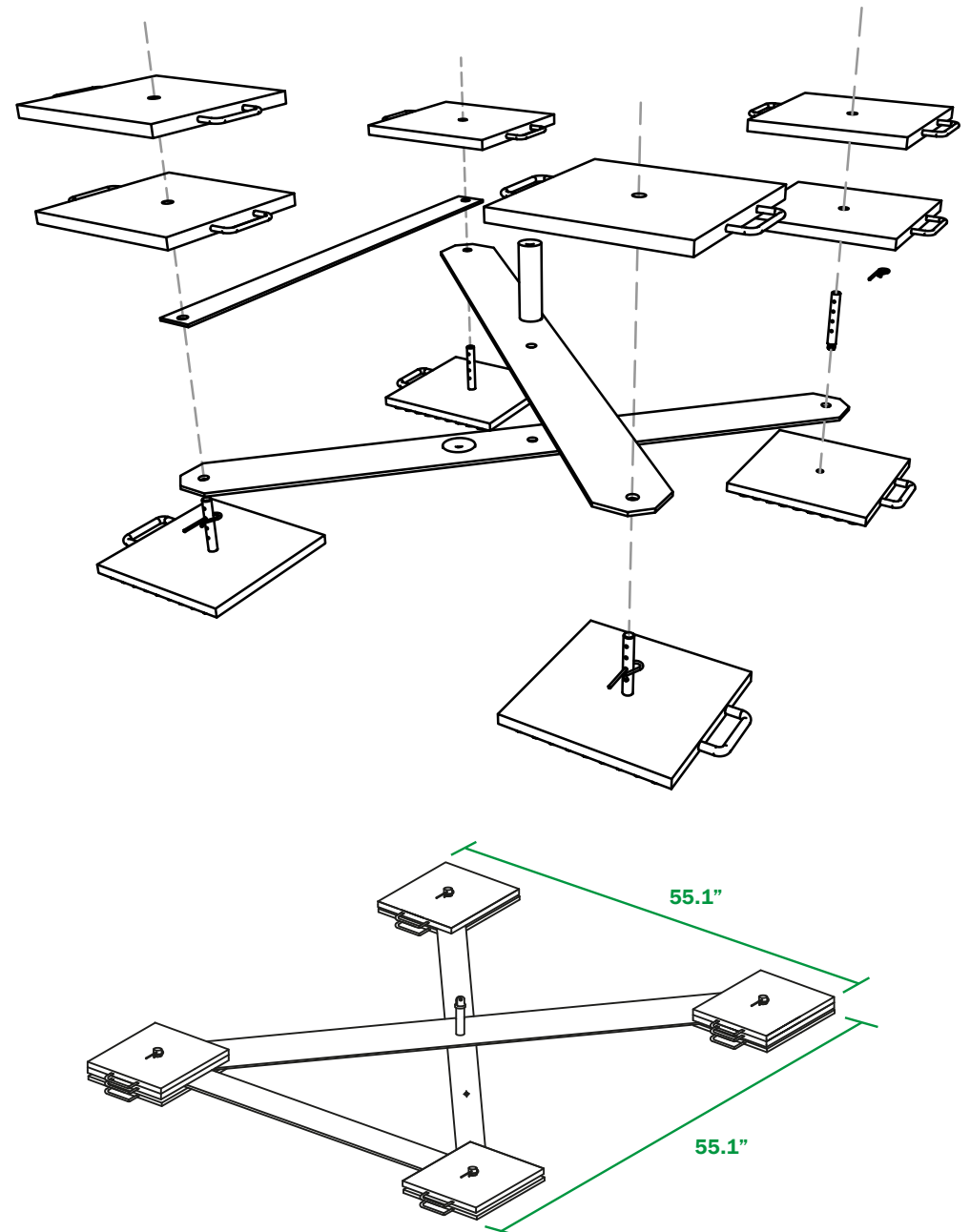

Keep Anchor Compliance to EN 795 Class E

WEIGHTANKA SYSTEM

The CE Approved Weightanka® is a Portable Deadweight Anchor device which is an item of Personal Protective Equipment (PPE). Weightanka® has been specifically designed to provide short term safety for low frequency operations where collective protection is not provided. The unit is ideal for short term maintenance operations to flat roofs or to the plant and equipment installed at roof level such as AC units, telecommunications equipment etc. Weightanka® is extremely compact, portable, and easily assembled.

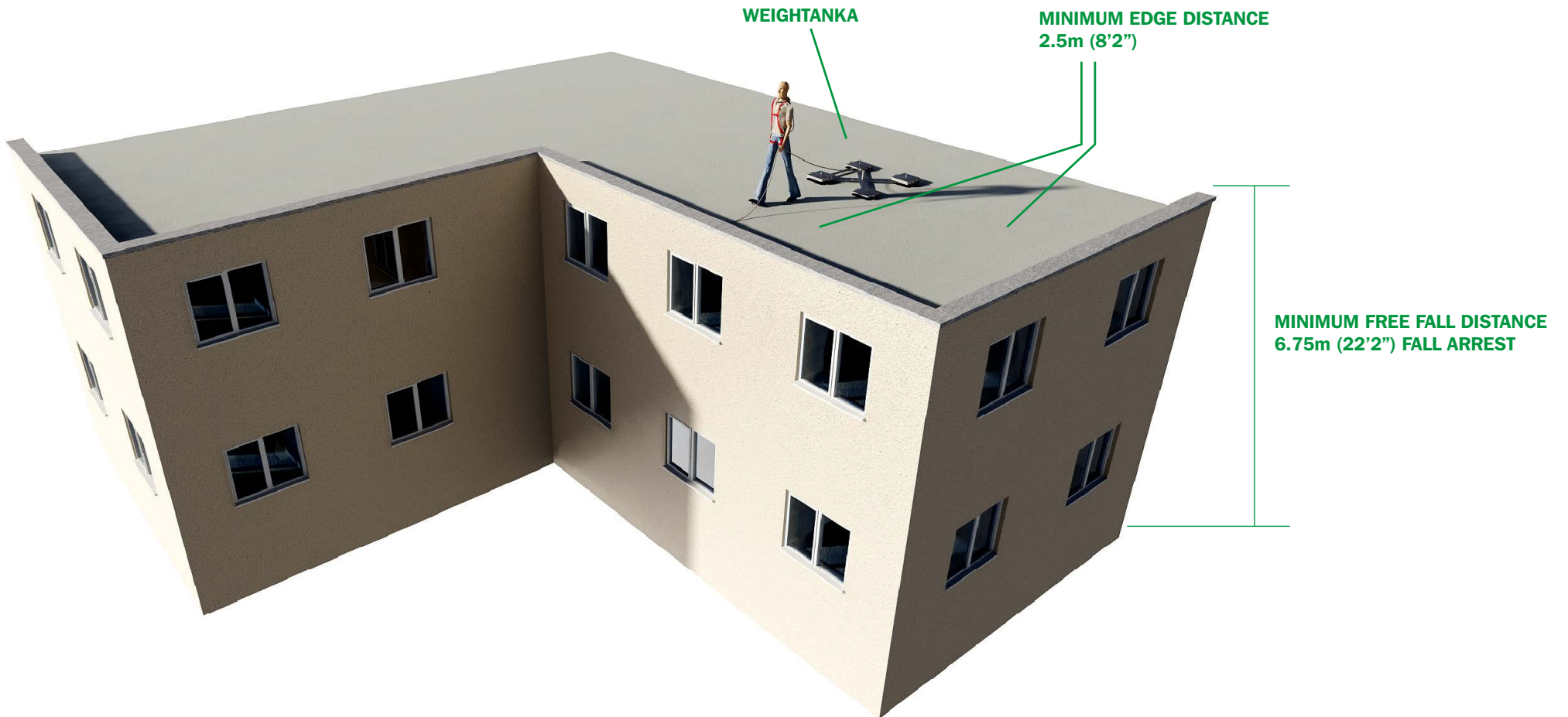

WEIGHTANKA - SEE TABLE FOR TECHNICAL INFORMATION

Kee Anchor Compliance to EN 795 Class E

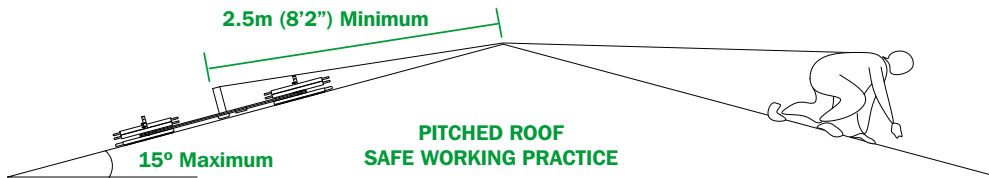

WEIGHTANKA PRODUCT

Type of Roof Surface	Quantity of Rubber Weights	Quantity of Galvanised Weights
Bituminous		
Asphalt Total Mass - 250kg (551lb 3oz)	4	6
Mineral Felt Total Mass - 250kg (551lb 3oz)	4	6
Single Ply Membrane		
(Flat, Smooth) Total Mass - 300kg (661lb 6oz)	4	8
(Embossed) Total Mass - 400kg (881lb 13oz)	4	12
Loose Stones (All loose stones to be brushed)		
On Asphalt Base Total Mass - 250kgs	4	6
On Mastic Base Total Mass - 250kg (551lb 3oz)	4	6
Concrete		
Total Mass - 250kg (551lb 3oz)	4	6
Steel Cladding		
Total Mass - 300kg (661lb 6oz)	4	8



Kee Wireanka Compliance to EN 795 Class C

WIREANKA SYSTEM

The Wireanka® System consists of a series of Weightanka's® linked via the KeeLine® horizontal lifeline system.

Wireanka can be designed as a complete restraint or fall arrest system for up to two users and complies with EN 795 Class C & E and ISO 14567.

A series of Weightanka's® can be linked at approximate 15m centres via the KeeLine® horizontal life line. The KeeLine® horizontal life line provides the operative with hands-free operation so that when a bracket is encountered, the shuttle attaching the operative to the system glides over the bracket without the need to detach. This type of installation is ideal if a free standing solution is required in order to avoid roof membrane penetration, or the roof design is not suitable for structural fixings associated with horizontal lifeline installations. This configuration of equipment ensures compliance with HSG 33 requiring "demarcated" safe areas/routes to ensure operatives remain within a specific area.

Consideration must be given to ensure that when designed as a "fall restraint" system the operatives remain unable to reach any roof edge/void. It is essential the combination of PPE is appropriate for the particular designed system.

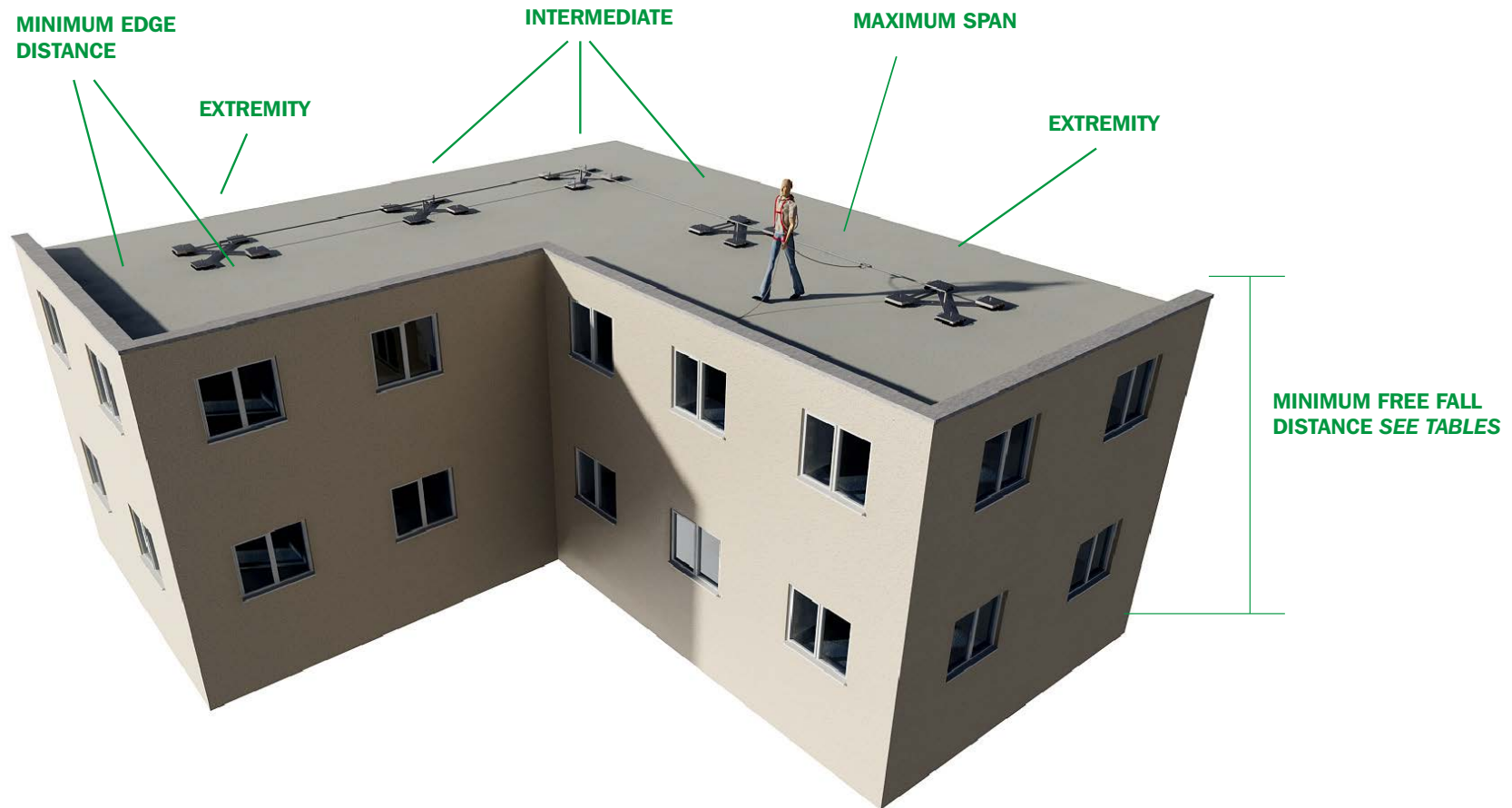

TYPICAL WIREANKA LAYOUT - SEE TABLE FOR TECHNICAL INFORMATION

Kee Wireanka Compliance to EN 795 Class C

FALL RESTRAINT SYSTEMS

Max Span	All Systems					
	5m (16'5")	6m (19'8")	8m (26'3")	10m (32'10")	12m (39'4")	15m (49'3")
Min Edge Distance	2.5m (8'3")	2.5m (8'3")	2.5m (8'3")	2.5m (8'3")	Consult Technical Department	

EXTREMITY / CORNER PEDESTAL MASS

Type of Roof Surface	Quantity of Rubber Weights	Quantity of Galvanised Weights
Asphalt, Concrete Mineral Felt Stonce Chippings Total Mass - 300kg (661lb 6oz)	4	8
Steel Clad Roofs Total Mass - 350kg (771lb 9oz)	4	10
Single Ply Membrane (Flat, Smooth) Total Mass - 400kgs (881lb 13oz)	4	12
Single Ply Membrane (Embossed) Total Mass - 500kg (1102lb 5oz)	4	16

INTERMEDIATE PEDESTAL MASS

Type of Roof Surface	Quantity of Rubber Weights	Quantity of Galvanised Weights
Asphalt, Concrete Mineral Felt Stonce Chippings Total Mass - 250kg (551lb 3oz)	4	6
Steel Clad Roofs Single Ply Membrane (Flat, Smooth) Total Mass - 300kg (661lb 6oz)	4	8
Single Ply Membrane (Embossed) Total Mass - 400kgs (881lb 13oz)	4	12

FALL ARREST SYSTEMS

Max Span	All Systems					
	5m (16'5")	6m (19'8")	8m (26'3")	10m (32'10")	12m (39'4")	15m (49'3")
Min Free Fall Distance	5.2m (17')	5.4m (17'8")	5.8m (19')	6.2m (20'4")	6.6m (21'8")	7.2m (23'7")
Min Edge Distance	2.5m (8'3")	2.5m (8'3")	3.0m (9'10")	3.0m (9'10")	4.0m (13'1")	4.0m (13'1")



Keep Accessanka Compliance to EN 795 Class B

ACCESSANKA

Accessanka® is designed as an accessory to Weightanka® to provide a portable anchor device for rope access workers, allowing them to work safely. It does not penetrate the roof, is suitable for most flat roof surfaces and requires no attachment to structural members. When correctly installed, the system is extremely stable and will not migrate across the roof surface either in normal use or when arresting the fall of both a worker and rescuer up to 200Kg limit.

Accessanka® conforms to Class B EN 795, BS 7883 & ISO 14567.



ACCESSANKA - SEE TABLE FOR TECHNICAL INFORMATION

Kee Accessanka Compliance to EN 795 Class B

INTERMEDIATE PEDESTAL MASS

	Accessanka
Min Edge Distance	2.5m (8'2")
Min Parapet Legs Distance From Edge	260mm (10.2")

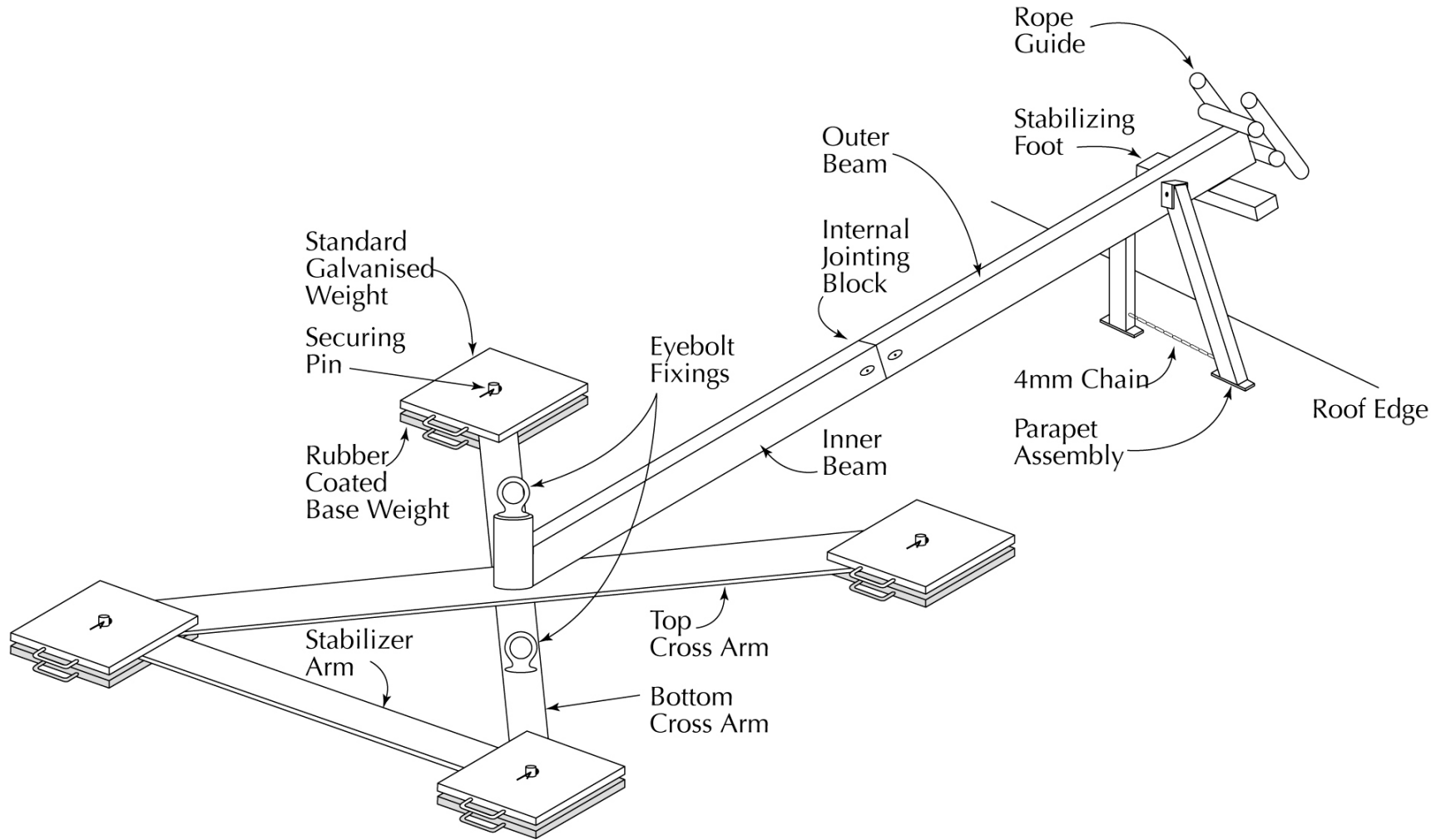

Personal Fall Protection Systems

PERSONAL FALL PROTECTION SYSTEMS

Personal fall protection systems are required when an operative is working at an elevated level with an unprotected side or edge, which can be at any height. The system must be designed in such a way to prevent the operative from free falling more than 2m (6'6") or striking a lower level. There are two ways that a company can accomplish this task: Fall Restraint or Fall Arrest.

FALL RESTRAINT SYSTEM

This system does exactly what it states. It is designed in such a way as to restrain the user from falling by not allowing the user to get to the leading edge. With this system the free fall distance is ZERO. Belts can be used with this type of system but a full body harness is recommended. If any possibility of a free fall exists then the user needs to use a Fall Arrest system.

FALL ARREST SYSTEM

A fall arrest system consists of the following components: Anchor, Connector, Body support and Retrieval.

- Anchors need to have a minimum breaking strength of 10kN or be engineered for a specific system and have a safety factor of 2:1.
- Connectors can consist of one of several different means. A positioning lanyard, a deceleration lanyard, a self-retracting lanyard/life line or a climbing aid device.
- Body support is a full body harness. A full body harness

distributes the fall impact throughout the body and allows the user to better absorb a fall.

- When working in a fall arrest situation it is a legal requirement for the employer/building owner to have a rescue policy and plan in place and not to rely solely on the emergency services. Anyone responsible for or working at height must be trained fully on correct rescue procedures including how to use the rescue kit provided. Should an emergency occur, a competent first aider should be present to assist with the casualty and to follow the standard first aid guidance for the recovery of a person.

KEY COMPONENTS OF A FALL ARREST SYSTEM

There are a number of issues that need to be addressed when considering using a fall arrest system.

IMPACT FORCE (EUROPEAN)

The maximum impact force for a full body harness is 6kN and 10kN for the anchorage point. Calculating the impact force is difficult because there are so many variables. These variables include fall distance, person's weight, and attachment method (self retracting life line, shock-absorbing lanyards, etc.). (See [Table for North America Fall Protection Regulations](#))

EQUIPMENT COMPATIBILITY

It is important that the equipment being used is compatible with one another. The entire system needs to be measured by its weakest link. Conventional locking snap hooks need to be used with compatible D-ring connectors. It is a general recommendation that a user does not mix fall protection equipment from various manufacturers in order to avoid a compatibility issue and to ensure maximum manufacturer guarantee of quality and use.

FREE FALL DISTANCE

In layman's terms, it is the distance that a person falls before any part of the system starts to arrest the fall. Free fall is measured from the anchorage point to the point in which the system started to arrest the fall. This distance excludes deceleration distance and lanyard/harness elongation. Maximum free fall distance is 2m (6'6") or striking a lower level.

TOTAL FALL DISTANCE

Is measured as the distance the operative fell from the point at which they were standing to the position of their feet after the fall. Free fall and deceleration distances are included in the measurement. [See falling distances diagram.](#)

ANCHORAGE POINTS

Need to be rated at a minimum of 10kN (2248lbs) per person. If engineered, they need to have a 2:1 safety factor. (Minimum USA requirement is 5000lbs.). (See [Table for North America Fall Protection Regulations](#))

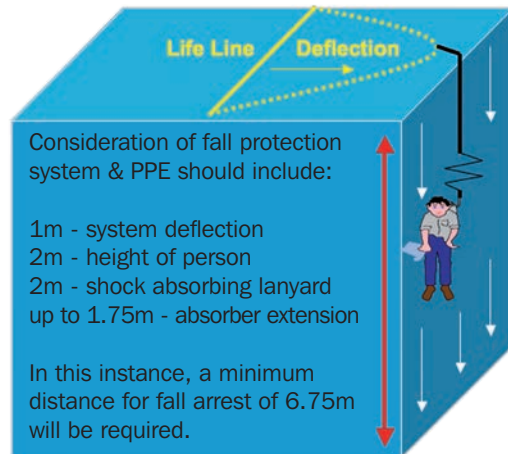

Typical Pendulum Effect

A, B, C – safe positions D – risk of a fall arrest situation

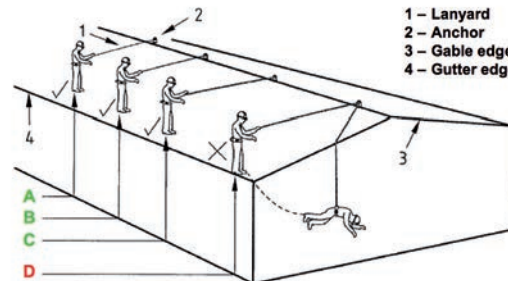

Limitations and dangers of using a restraint system on a sloping roof

Plan of Roof

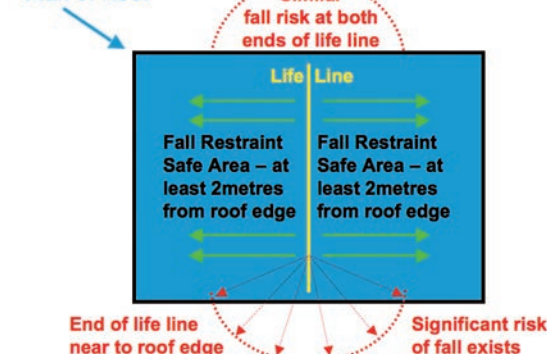

Fall restraint system unsuitable for this roof arrangement



North American Fall Protection Regulations	Canadian Federal	British Columbia	Alberta	Saskatchewan	Manitoba	Ontario Industrial	Ontario Construction Industry	Quebec	New Brunswick	PEI	Nova Scotia	Newfoundland & Labrador	Northwest Territories & Nunavut	Yukon	US Fed OSHA General Industry	US Fed Construction Industry
	COSH S2.5, 2.9, 12.10	Reg 420/2004 Parts 4 & 11	Part 9	OH&S Reg. 1996 S102 & 116	Reg 217/2006	ON Reg 851-90	Reg 213/91	LSST C.S-2.1 r.19.01 S346	Act O.C. 91-1035 Reg 1-191	EC633/04	OIC 96-14 Reg 2/96	OC 96-478	Reg C.S-1	O.I.C. 1986/164	CFR 1910.23 & 1910.66	CFR 1926.502
Year of Last Amendment	1994	2007	2009	2007	2006	2006	2005	2006	1991	2004	1996	1996	2000	1986	1994	1994
Threshold of Height for Fall Arrest	8ft	10ft	10ft	10ft	8ft	10ft	10ft	10ft	10ft	10ft	10ft	10ft	10ft	10ft	6ft	6ft
Threshold of Height for Guard Rails (Premanent Work Locations)	4ft	4ft	4ft	4ft	-	3.5ft	8ft	-	4ft	10ft	10ft	-	-	8ft	4ft	-
Maximum Free Fall (* = when no Personal Energy Absorber)	4ft	-	-	4ft	4ft	5ft	-	4ft	4ft	4ft	4ft	4ft	4ft	4ft	6ft	6ft
Maximum Deaccelartion Distance	-	-	-	-	-	-	-	-	-	-	-	-	-	-	3.5ft	3.5ft
Maximum Arretsing Force	1800 lb	-	8 kN	8 kN	8 kN	8 kN	8 kN	-	-	-	-	-	-	-	1800 lb 900 lb	1800 lb 900 lb
Adopted Z259.16	-	Y	Y	-	Y	-	-	-	Y	Y	-	Y	-	-	-	-
Minimum FAS Anchor Strength	4000 lb	5000 lb 2xMAF	3600, Z259.16	5000 lb	(3600 lb) FOS x8 kN	5000 lb	4000 lb	4000 lb	4000 lb	4000 lb	4000 lb	-	-	-	5000 lb 2 x MAF	5000 lb 2 x MAF
Minimum Travel Restraint Anchor Strength	-	800 lb	800 / 3600 lb	800 / 3600 lb	900 lb = FOS x 400 lb	-	900 lb = FOS x 400 lb	-	-	-	-	-	-	-	-	-
Written Fall Protection Plans/Procedures	Y	> 25 ft	> 10 ft	> 10 ft	-	-	Y	-	-	-	-	-	-	-	-	-
Procedures Based Fall Protection	-	Limited	Limited	-	Roofing	-	-	-	-	-	-	-	-	-	-	Limited
Written Rescue Plans/Procedures	-	Y	Y	Y	-	-	-	-	-	-	-	-	-	-	-	-
Training of Workers (F = Fall Protetcion, R = Rescue)	F.R.	F.R.	F.R.	F.R.	-	-	F	-	-	-	-	-	-	-	-	-
Control Zones/Warning Lines	-	-	Y	Y	-	-	-	-	-	-	-	-	-	-	-	Y
Swing Falls/Swing Drop Distance	-	-	4 ft	-	-	-	-	-	-	-	-	-	-	-	-	-
Horizontal Lifelines to Z259 13 or Z259 18	-	Z259.13 Z259.16	Z259.13 Z259.16	-	Z259.13 Z259.16	-	Engineered	-	-	Z259.13 Z259.16	-	Z259.13 Z259.16	-	-	2 FOS	2 FOS
Fall Protection Equipment (CSA Z259 Series, ANSI Z359.1, EN Series)	CSA	CSA/ANSI	CSA/ANSI EN	CSA	CSA	CSA	CSA	CSA	CSA	CSA	CSA	CSA	CSA	CSA	-	-

Minimum Height Requirements

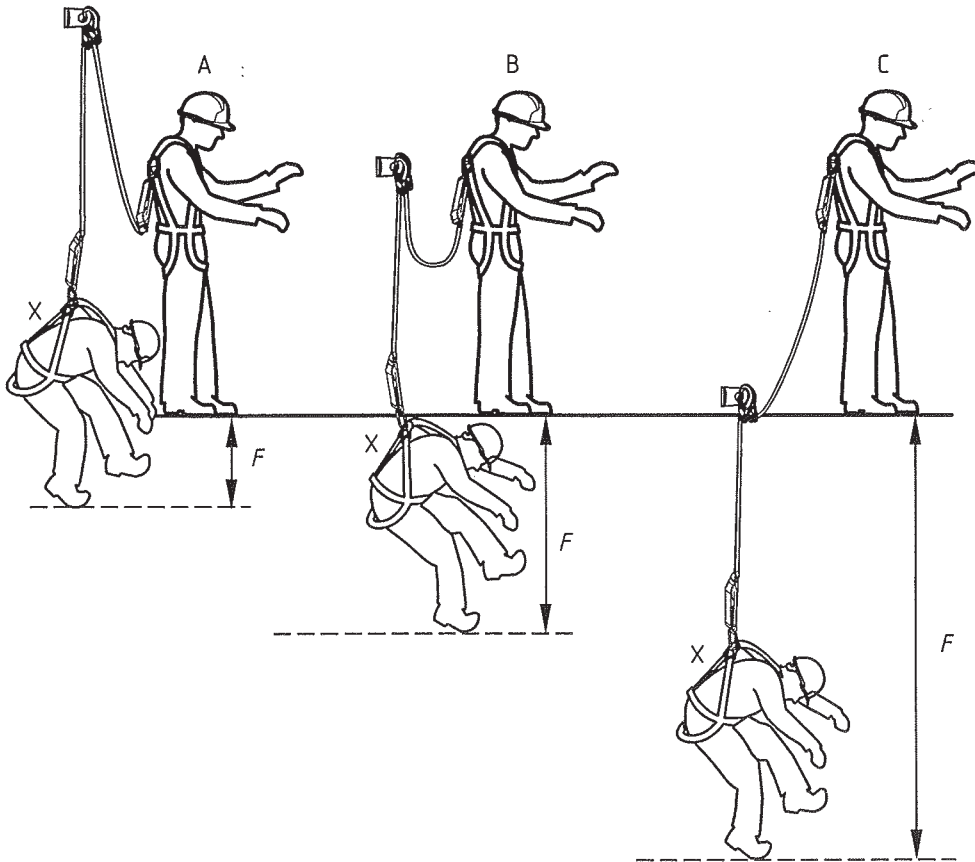

DIAGRAM A

Anchor point above user. (In this case 1m (3.28') above user's harness attachment point)
(Preferred Option)

Free fall distance: 0.5m (1.64')

Fall factor = $0.5/1.5 = 0.3$ ($1.64/4.92 = 0.3$)

DIAGRAM B

Anchor point at shoulder level.
(Non-preferred option)

Free fall distance: 1.5m (4.92')

Fall factor = $1.5/1.5 = 1.0$ ($4.92/4.92 = 1.0$)

DIAGRAM C

Anchor point at foot level.
(To be avoided)

Free fall distance: 3.0m (9.84')

Fall factor = $3.0/1.5 = 2.0$ ($9.84/4.92 = 2.0$)

NOTE: The lower human figure in each diagram indicates the position of the user at the end of the free fall. This is the point at which the energy absorber begins to deploy and should not be confused with the position the user would be in at the end of the arrest of the fall.

KEY

F = Free fall distance

(Source BS 8437:2005)

The above diagram shows three fall arrest situations. In each case the fall arrest system is based on a 1.5m (4.92') long energy absorbing lanyard and a distance between the attachment point on the user's harness and their feet of 1.5m (4'92"). The free fall distance is the vertical distance between the position of the user's feet immediately before the fall, and the position of the user's feet at the point at which the lanyard has become taut and started to arrest the fall. (Figure F in the diagram)

Work at Height Rescue

Before commencing any work at height activity please ensure you are adequately trained and competent to carry out the task and able to use the safety equipment provided by your employer/building owner.

In situations where a work at height activity involves a “fall arrest” situation, it is a legal requirement for your employer/building owner to provide the anchorage point, rescue plan, policy, training and equipment to complete a rescue. It is not the responsibility of the emergency services to conduct such a rescue.

Should a rescue become necessary it is extremely important that the procedures detailed in the “roof permit to work,” rescue policy and plan are followed. Try to make contact with the casualty to establish if they are conscious or unconscious. If they are unconscious then time is of the essence.

Contact the emergency services and request an ambulance and fire/rescue support. Inform them of the exact address, location and site contact details of where you are working (This should be contained within the “permit to work”). Confirm that you are trained and competent to commence the rescue procedure.

Call your site contact and inform them of the situation and that you have already contacted the emergency services. Request they bring a competent First Aider to assist you at ground level by receiving the casualty. Before commencing the actual rescue, ensure that you are safely connected to an alternative suitable anchorage point (where possible). Ensure you work in “fall restraint” at all times whilst conducting the rescue procedure. Check you have all the Rescue Kit components as shown in the diagram below.

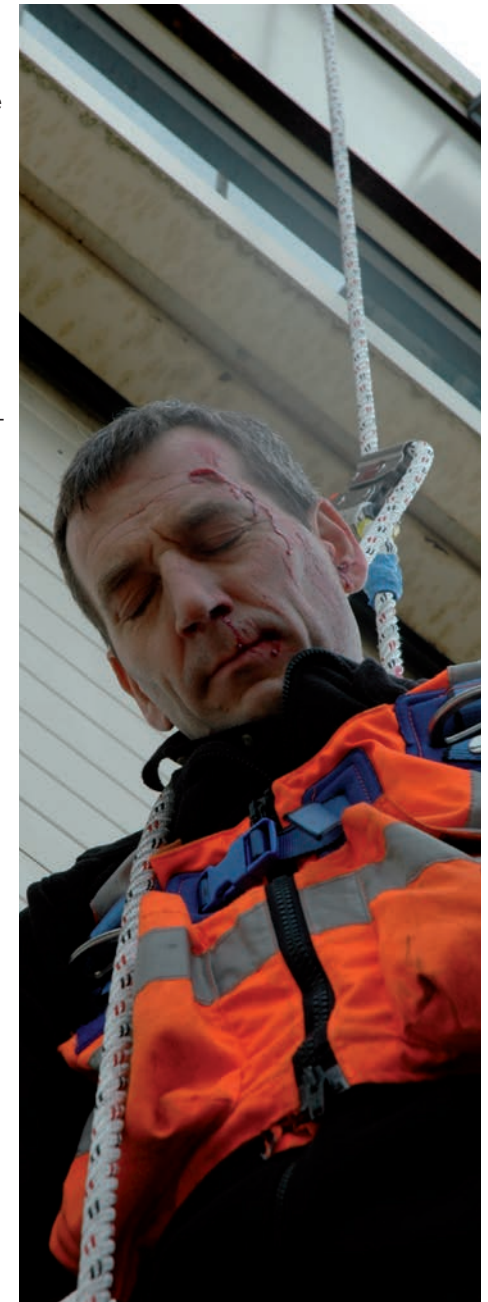

Before commencing the actual rescue, ensure that you are safely connected to an alternative suitable anchorage point (where possible). Ensure you work in “fall restraint” at all times whilst conducting the rescue procedure. **Check you have all the Rescue Kit components as shown in the diagram above.**

Rescue Kit Operation

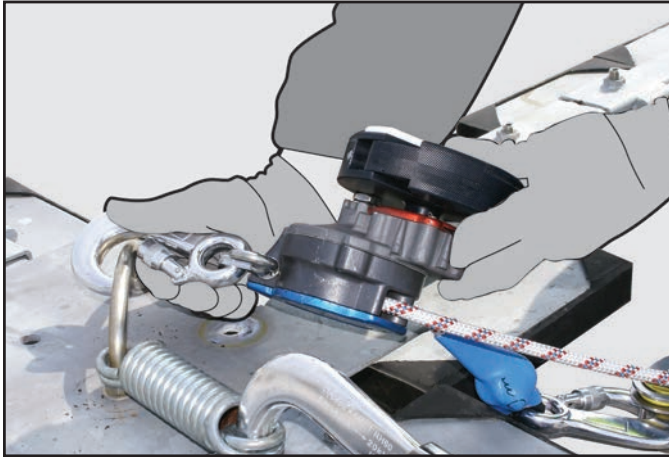

a. Connecting to the same or an alternative suitable anchorage point. Connect the Rescue Hub device using the Screw Gate Karabiner fitted directly to the Rescue Hub. Ensure the Screw Gate is tightened once connected to the anchorage point.

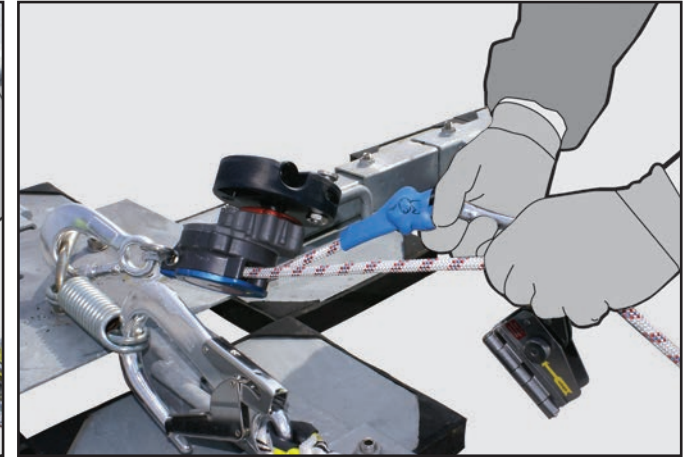
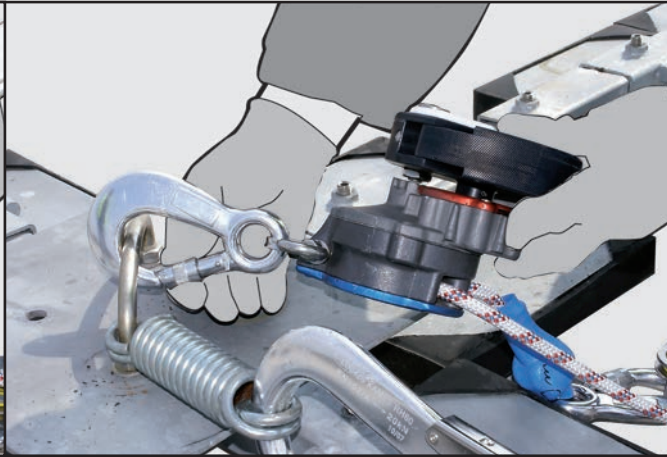

b. Pull the end of the Kernmantel Rope which has the Rescue Rope Grab attached. The Kernmantel Rope will start to feed out of the rescue bag and run through the Rescue Hub.

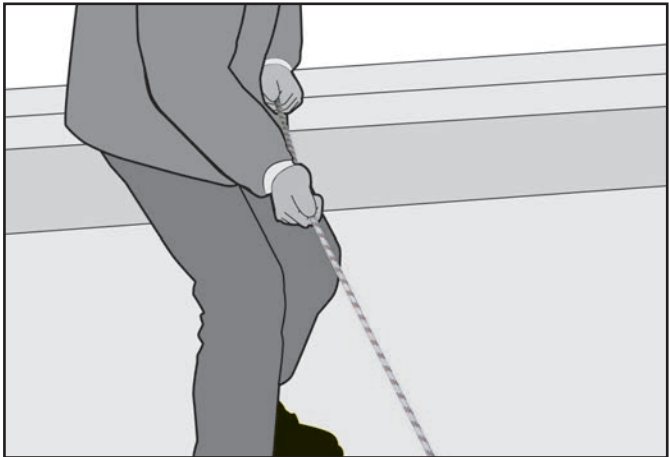

c. Start walking towards the area where the casualty has fallen whilst still holding the Rescue Rope Grab. When you reach this area, kneel down and continue to pull out sufficient rope to reach the “D” ring on the casualty’s harness.

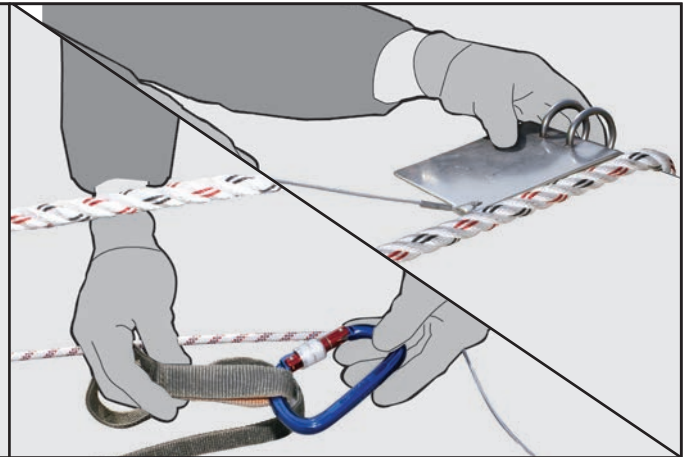
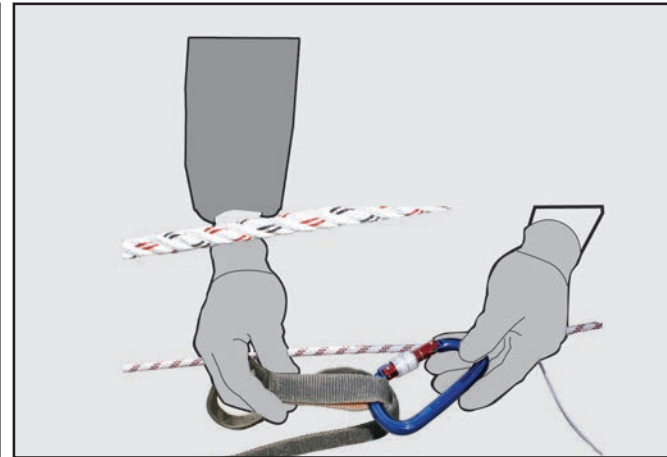

d. Ensure the Edge Protector is connected to the anchorage point, this may need to be extended in some cases via a webbing or rope sling. Place the Edge Protector over the edge ready for the rescue operation.

Rescue Kit Operation

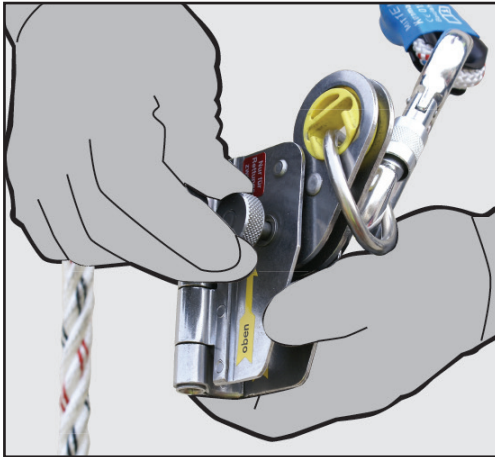

e. Whilst holding the Rescue Rope Grab unscrew the Screw Gate as shown above.



f. Turn the Rescue Rope Grab over and push the lever in an upwards direction.

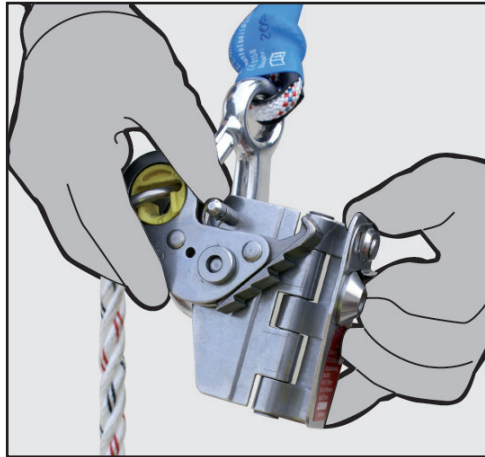

g. The Rescue Rope Grab will now open.

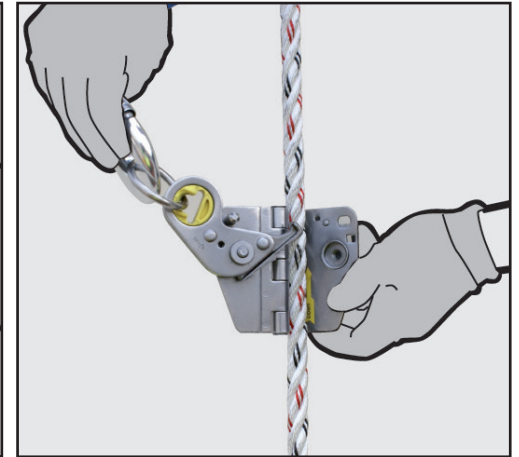

h. Ensure you have adopted a “fall restraint” position. Carefully lean over the leading edge and pass the open Rescue Rope Grab (with the arrow in the up direction) around the back of the casualty’s rope. (cont)

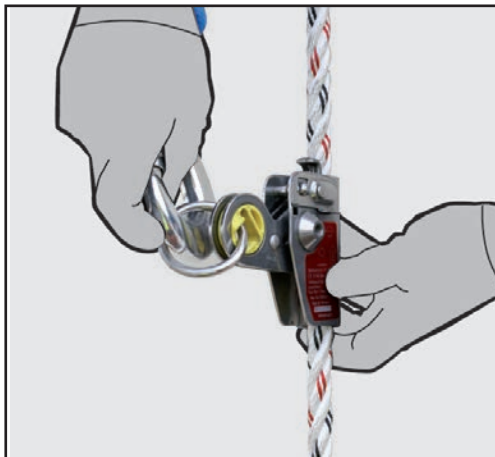

i. . (cont) Ensure the casualty’s rope is correctly positioned inside the Rescue Rope Grab. Close the Rescue Rope Grab.



j. Once the Rescue Rope Grab is closed ensure the Screw Gate is then tightened into position.

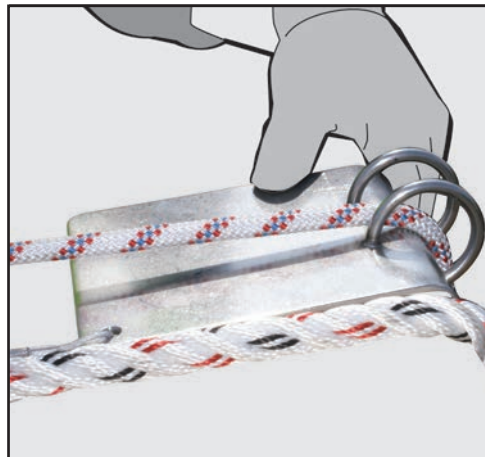

k. Position the Rescue Kernmantel Rope over the Edge Protector. Now carefully lower the Rescue Rope Grab down towards the casualty. The Rescue Rope Grab device will descend easily under gravity to the “D” ring of the casualty’s harness.



Rescue Kit Operation

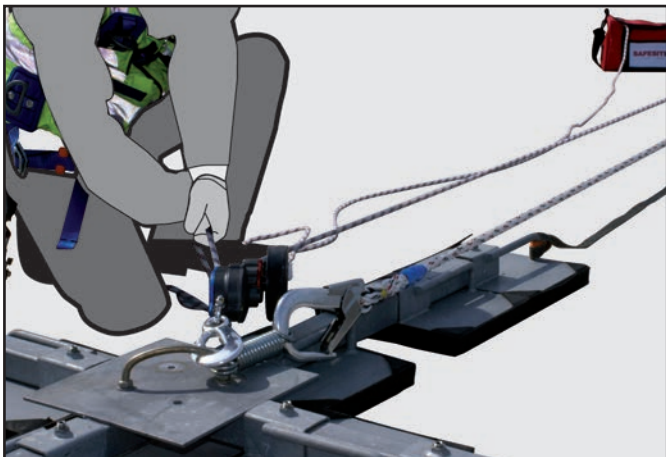

l. Return to the anchorage point where the Rescue Hub is connected. Pull any excess Kernmantel Rope through the Rescue Hub by pulling the free end of the rope which is stored in the bag.

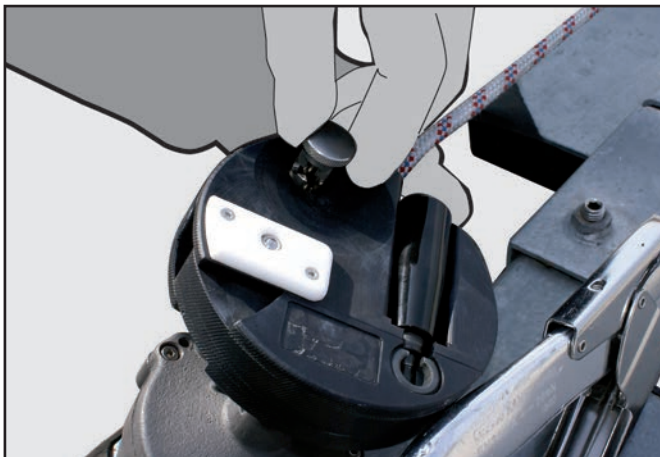

m. Once the Rescue Hub Kernmantel Rope is taught, rotate & lower the locking pin so that it engages with the body of the hub. When in place correctly, the hub cannot turn.

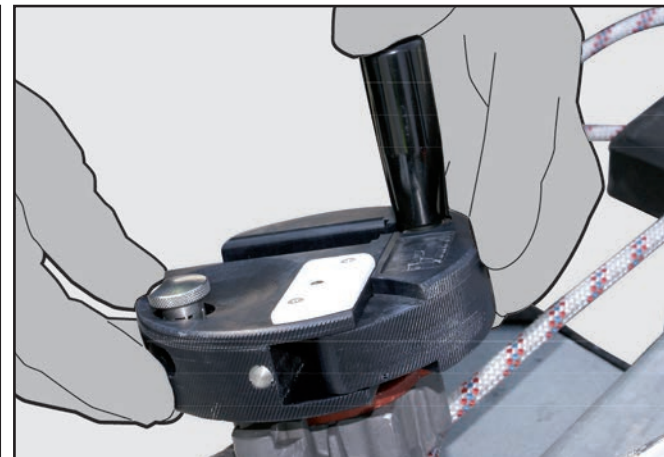

n. Lift up the black handle as shown above.

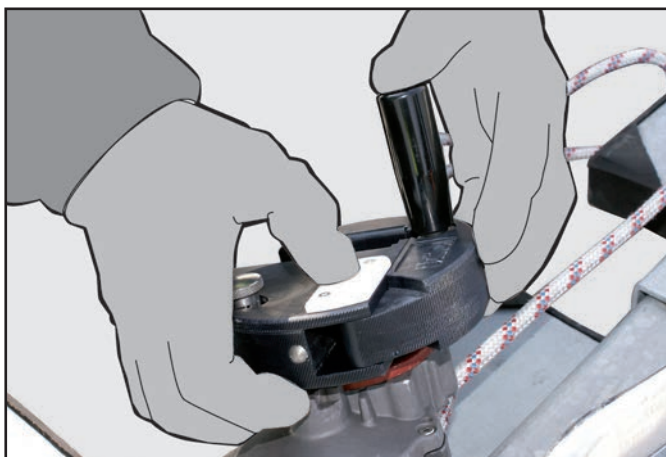

o. With the black handle in position push the silver ball bearing positioned in the centre of the white plate as shown above.



p. Now open the top third of the Rescue Hub and it will automatically lock into place.

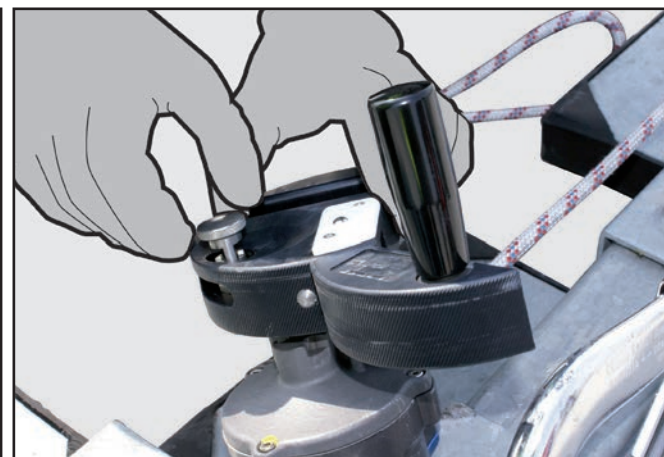

q. Detach the pin.

Rescue Kit Operation

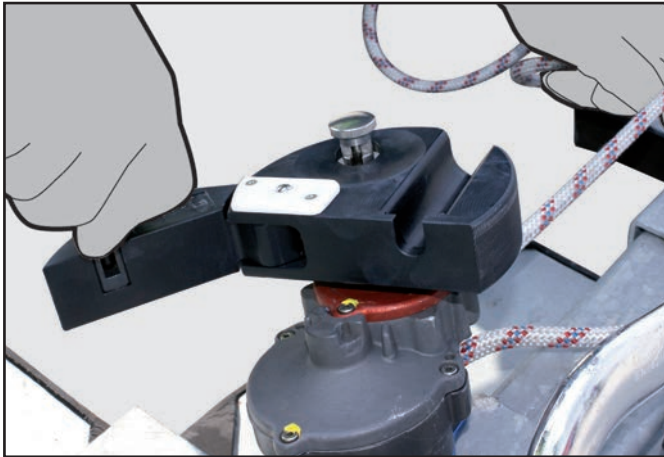

r. Start winding the Rescue Hub in a clockwise direction so that the Kernmantel Rope passes through the hub. If the rope does not move through the hub, pull on the free end of the rope. Continue to wind until the casualty's primary rope becomes slack.

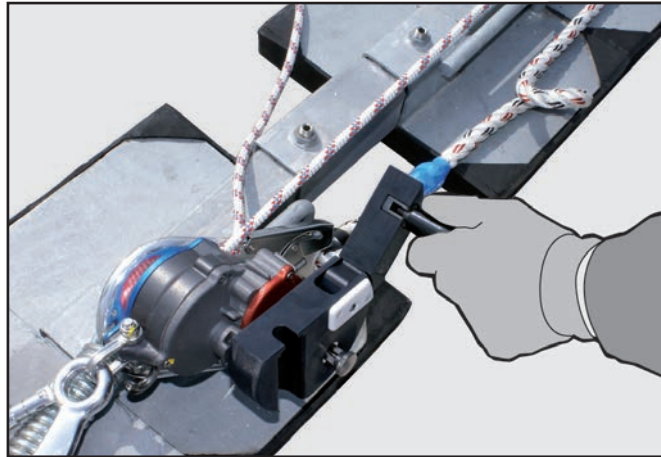

s. Once the casualty's primary rope is slack enough to detach their primary hook/karabiner from the anchorage point, stop winding and engage the locking pin by lifting, rotating & then lowering it. Ensure the pin is engaged against the body of the Rescue Hub. When in place correctly the Hub cannot turn.

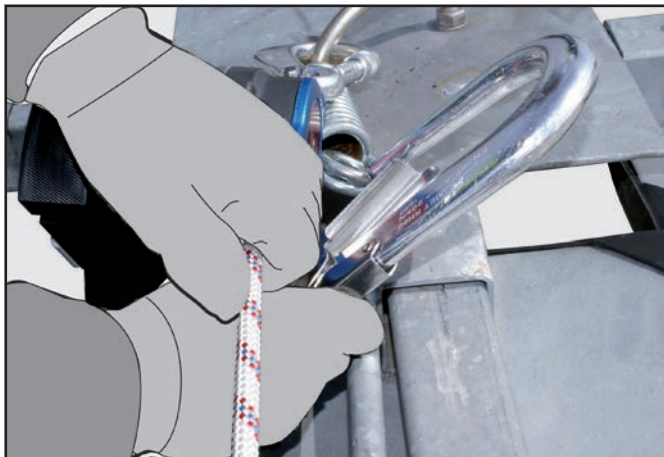
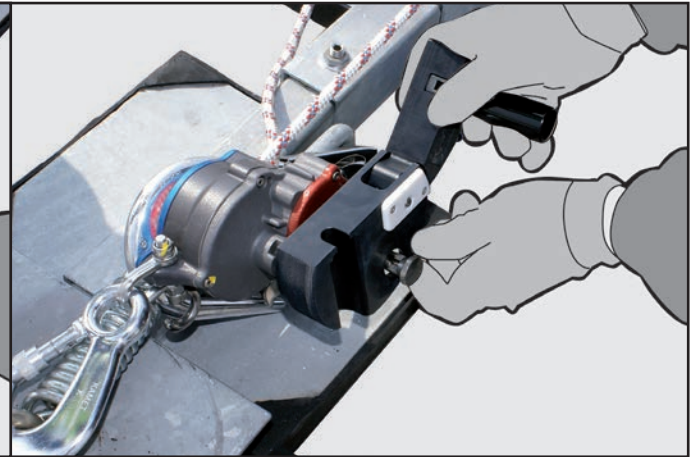

t. You can now remove the casualty's slack primary rope from the anchorage point as shown above.

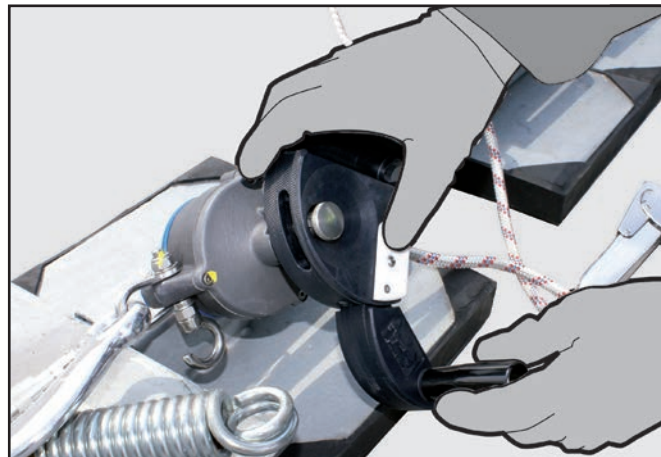

u. Close the Rescue Hub by pressing in the silver ball bearing in the centre of the white plate. Once closed fold down the plastic handle.

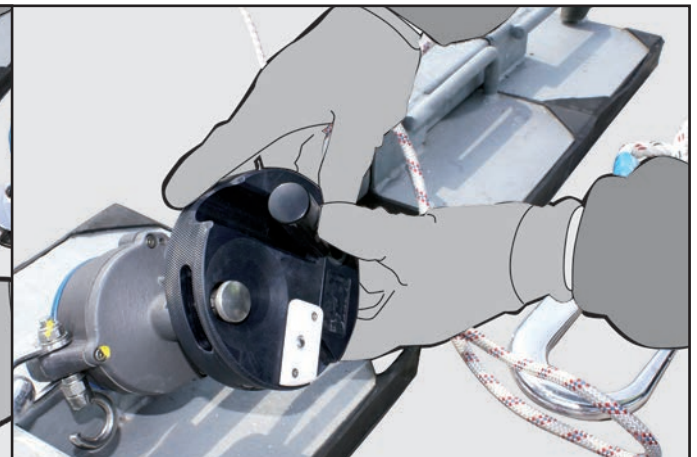

Rescue Kit Operation

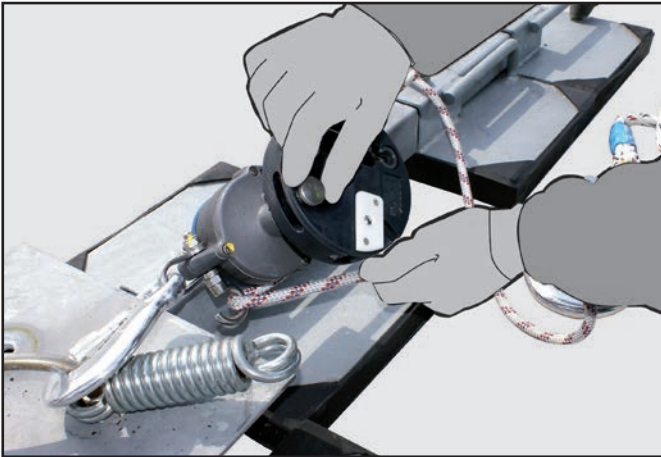

V. Pass the loose end of the Kernmantel Rope around the pig tail of the Rescue Hub. Hold the rope firmly in one hand. To take the load off the casualty, simply rotate and pull the Locking Pin upwards and rotate sufficiently so that the pin is disengaged from the Rescue Hub. Whilst holding the Kernmantel Rope you can move back towards the area where the casualty fell.

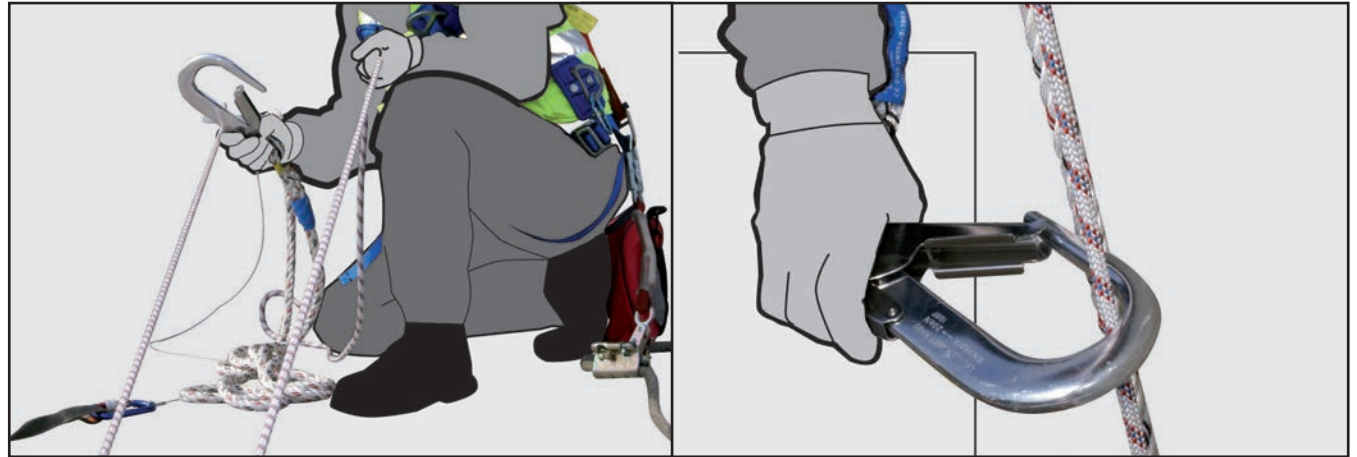

W. Once you are in a comfortable position and able to hold the casualty with one hand, take the casualty's primary rope which you previously disconnected from the anchorage point. When ready, carefully position yourself so you are able to attach this primary rope to the Rescue Hub Rope (Kernmantel Rope) as shown above. Ensure that you keep holding the Rescue Hub Kernmantel Rope at all times. Gradually lower the casualty's primary rope until the hook reaches the casualty's "D" ring. Ensure you are still holding the Rescue Hub Kernmantel Rope. You can now let the casualty's primary rope fall to the ground so that it can be used as a guy rope by those at ground level who are ready to assist/receive the casualty.

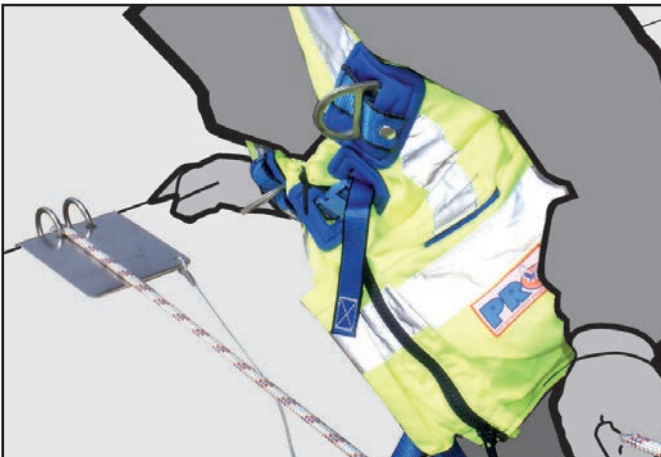

X. Begin to lower the casualty gradually, continually observing them and communicating with both the casualty and those at ground level who are receiving/assisting the casualty. The competent first aider must then follow the standard UK first aid guidance for the recovery of a person. The casualty must then be seen by the ambulance crew, even if they appear to have recovered.

- Periodic inspections by a competent person are recommended by the manufacturer. In UK/Europe these are required under Regulation 5 of the Workplace (Health Safety & Welfare) Regulation, BS EN 365 & BS 7883.
The frequency will depend upon environment, location and utilisation, but should be at least every 12 months.
- Walk & visually inspect the complete system installation (where applicable) in relation to the general client's needs. Establish if any modifications, additional products are required to reflect any refurbishment or additional plant and equipment that has been installed and requires access.
- Check installation configuration (where applicable) is complete as per the original installation drawing/plan.
- Ensure the system has not been modified/tampered with by unauthorised persons.

DETAILED COMPONENT INSPECTION:-

Cross Frame Components.

- Check arms on cross for distortion or dents.
- Check metal plate for distortion or cracks.
- Check for any general corrosion.

Vertical pins and clips

- Check for distortion along length. Ensure that this does not affect the fitting of the weight.
- Ensure thread is in good condition and the pin can be connected.
- Look for signs of cracks in metal - especially around any "bruised" areas.
- Check for any general corrosion.
- Check clips are still present and in good order to lock and unlock (ease of movement).

Counter weights

- Check the encapsulated rubber pads on the weights are in good order - no tears or rubber missing.
- Check handle for dents, cracking etc.
- Check for any general corrosion.
- Any galvanised components showing signs of corrosion, wire brush thoroughly and apply galvanised spray / paint as appropriate.
- If rusted significantly take digital photographs and include in the inspection report.
- Once all other inspection points are completed, check that the whole device is fixed securely in position with no obvious distortions in balance.

System Plaque

- Check system plaque (where applicable) position & mark up to reflect date of the next required inspection. Establish if additional plaques are required due to any refurbishment works.
- In the event of a fall the Dead Weight Anchor MUST be returned to the manufacturer for re-testing.



Scan this QR Code to find out more about Kee Safety products.



Kee Safety Limited
Cradley Business Park
Overend Road, Cradley Heath
West Midlands B64 7DW

Phone: +44 (0) 1384 632 188
Fax: +44 (0) 1384 632 192
sales@keesafety.com
www.keesafety.co.uk